



SUP & Sports

2022





OUR BRANDS

Paddle with Passion



A COMPLETE RANGE FOR ALL PRACTICES

ZRAY offers the most complete range of Stand-Up-Paddles available on the market today. With boards of all sizes and personalities from All-Around, Touring, Windsurfing to Racing you are sure to meet your customers' wildest requests.

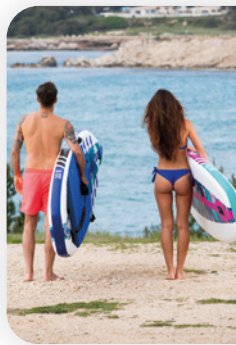

THE SKIFFO FAMILY

The Skiffo range of Stand-Up-Paddles has been designed and perfected to create memorable outings as a duo, with family or with friends.



WATTSUP IS THE GOOD DEAL!

The WattSup brand is designed for the public at large and of fers all a beginner is requiring to start exploring the wonders of water gliding from the youngest age.

A complete range that adapts itself to small frames, female body shape, solitary riders and those who prefer to share fun time on the water with friends and family.



HIGH PERFORMANCE INFLATABLE SUP

Design, Lightness, Rigidity, Durability and Eco-friendly Coasto is constantly evolving to remain at the forefront of progress and brings carefully studied solutions for the comfort of the rider. To meet today's market demand, every Coasto Stand-Up-Paddle is available either as a single chamber or double chamber solution. All material used in their conception is recyclable.

ZRAY™

- 8 / iSup Technology
- 10 / Art deco
- 11 / Aquajet
- 12 / Evasion
- 16 / X Rider
- 22 / Fury
- 24 / WindSurf
- 26 / Aileron
- 27 / Kayak
- 30 / Bodyboard
- 31 / Airdock



Skiffo

- 32 / The Skiffo Family
- 34 / Elle / Lui concept
- 36 / Elle
- 37 / Lui
- 38 / Suncruise collection
- 39 / Suncruise 10'2"
- 40 / Suncruise 11'2"
- 41 / Suncruise 12'
- 42 / Sea Scooter
- 43 / Accessories



WATTSUP

- 44 / The WattSup Experience
- 46 / ISup 1
- 47 / Isup 2
- 48 / Mako 10'5"
- 49 / Bream 10'6"
- 50 / Pike 11'6"
- 51 / Whale 14'6"
- 52 / Technology
- 53 / Guppy 9'
- 54 / Jelly 9'6"
- 55 / Sar 10'
- 56 / Espadon 11'
- 57 / Marlin 12'
- 58 / Seal 12'8"
- 59 / WingSup
- 60 / Accessories



COASTO

- 62 / Coasto Range
- 64 / Coasto Technologies
- 67 / Hook 7'5"
- 68 / Amerigo 10'4"
- 69 / Argo 11'
- 70 / Nautilus 11'8"
- 71 / Cruiser 13'1"
- 72 / Turbo 12'6"
- 73 / Super Turbo 14'
- 74 / Wings
- 76 / Kayak
- 80 / Rigid Sup
- 82 / Air Surf
- 83 / Soft Surf
- 84 / Towable Tube
- 86 / Wakeboard / Wakesurf
- 87 / Kneeboard / Surfskate
- 88 / Annexe
- 89 / Emotion
- 92 / Accessories

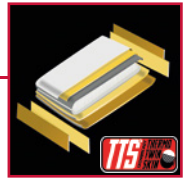

STAR

- 94 / Pump it up !
- 96 / Kayak Seat
- 97 / Paddles
- 99 / Electric air pump
- 100 / StarPump Revolution



Poolstar, services which make all the difference

1,000 m²
of office space

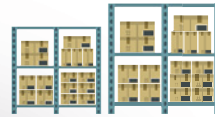

20,000 m²
of warehouse space



23
loading bays

Poolstar
Pure innovation



2
Indoor / Outdoor
Showroom

In-house after-sales service

Pickup area, testing bench and on-site repair



Poolstar, expertise with a personal touch

Poolstar has grown considerably since it was created with just 3 employees in 2006. Today, it counts over 60 members of staff in France and around the world. But, in our company, human touch remains the core of our activities. Customer satisfaction is our key priority.

Flexible and tailor-made services

As a truly-flexible company, Poolstar provides personalized responses according to your profile, requests and constraints. A dedicated support for exchanging with sales teams in the field and in our offices enhances communication with our customers.

A close relationship

Poolstar's organization is designed in such a way that every customer benefits from a close, professional relationship. You work with a dedicated contact person who knows your customer record fully. Your calls are answered directly by a real person and not an automated machine. Sales staff in the field and support teams work constantly hand-in-hand to ensure optimal response quality.

Commitment to continual improvement

In an effort to always improve customer satisfaction, Poolstar carries out studies and uses those results to progress. Driven by a commitment to continue our service quality improvement, we remain constantly attentive to your needs.



Four Giant SUP Supplier



2022
COLLECTION



ZRAY®

PADDLE with PASSION...

PADDLE with Passion

EXPLORE AND ENJOY YOUR ADVENTURE



KAYAK & BOAT

EXPLORING & CRUISING



Cosmetic Art Printing Technology

Cosmetic Art Printing (CAP) Technology is an auto printing process based on pre-designed patterns at high resolution using the best material of our board. It allows print at single colors and complicated textures and ensures color intensity and fastness to resist over time.

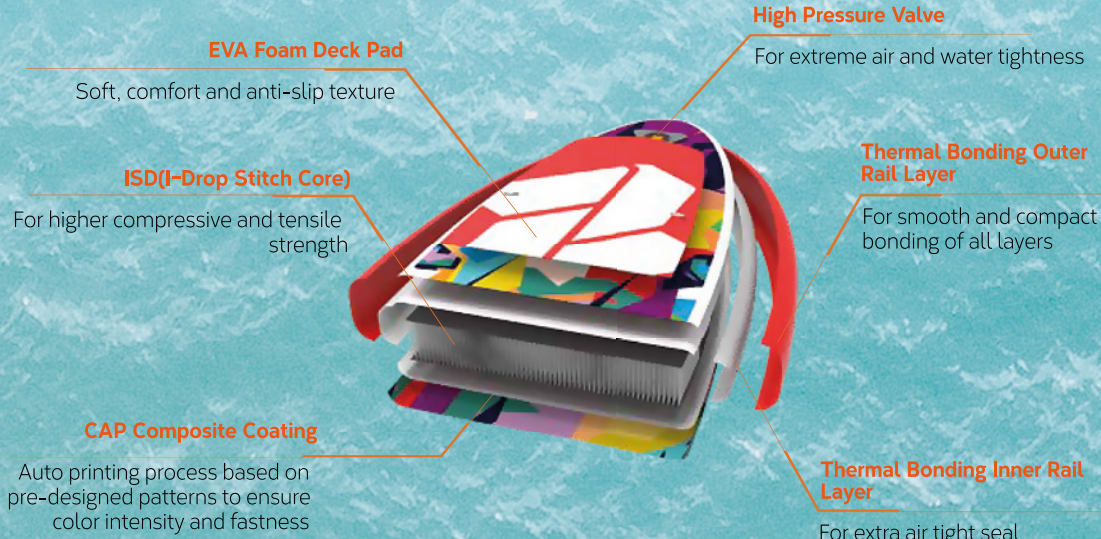

Ultimate Agile Light Technology

Specially developed for the portable boards. Extremely decrease the weight of boards to transport a single packaged board easily anywhere.

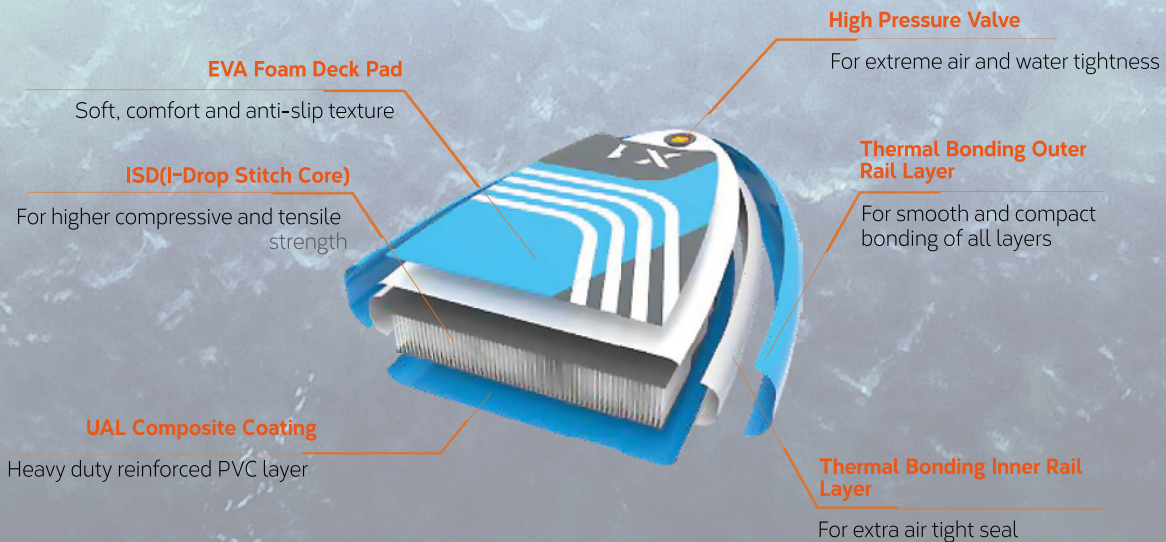

Balanced Anti-bending Motility Technology



A epochal innovation for the construction of our performance boards. We develop it to keep the balance between stiffness and weight of boards.

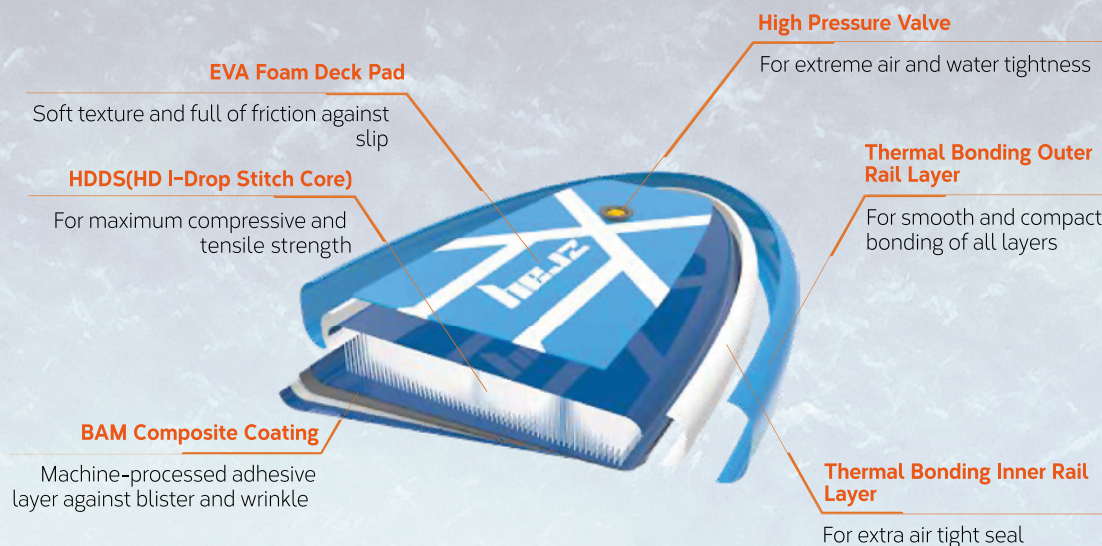

Duplex Rigid Heavy Duty Technology



A premium construction especially designed for racing lines. It provides an outstanding durability/price/performance ratio with its multilayer coatings.

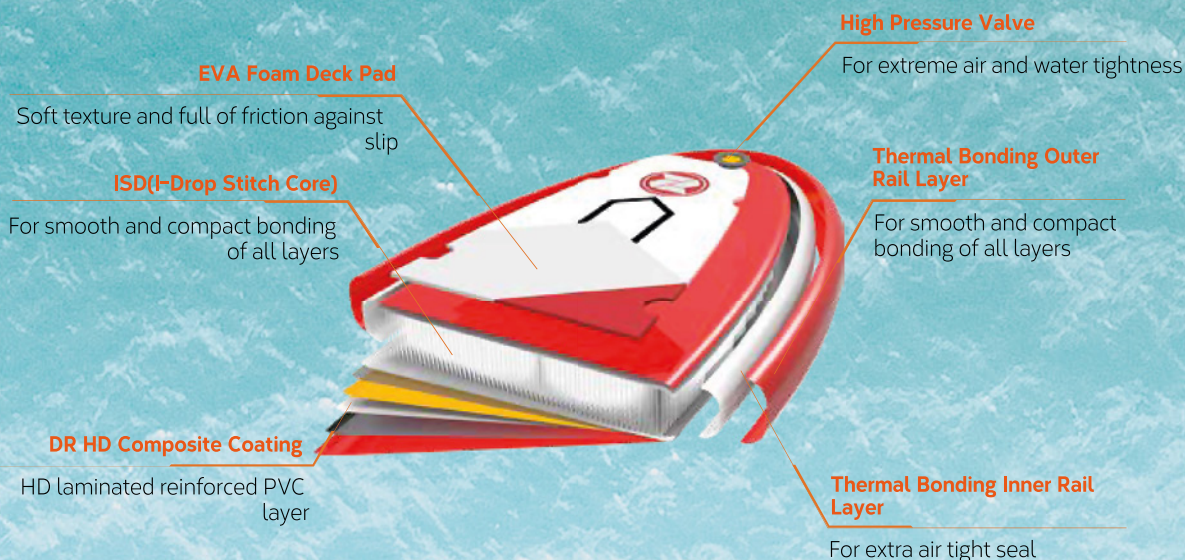



P1-34151
10'6" x 32" x 6"
320x81x15cm

LEO

NOBLE & POWER

The inspiration comes from the Leo meteor shower. The passionate and energetic image of the Lion King is supplemented by stained glass effects of various colors, just like the feast of the falling stars of Leo. When you are paddleboarding, you dominate the waters under your feet, just like the lion king's supreme power.



P2-34150
10'6" x 32" x 6"
320x81x15cm

ALIEN

FANTASY & IMAGINATION

No one doesn't like things with sci-fi colors. Just like the design of this board, the sci-fi elements of aliens are integrated into it, combined with SUP, a leisure water sport, to relax with a fantasy world.



P3-34152
10'6" x 32" x 6"
320x81x15cm

DOODLE

PAINTING & JOY

We all scribbled when we were young, even if we are blamed, we are still tireless, and that joy is hard to find now. This board combines doodle painting and joy with stand-up paddle boarding, allowing you to experience tireless sliding.



P4-34153
10'6" x 32" x 6"
320x81x15cm

SKETCH

NATURE & PASSION

Beach, nature, and surfing have always been the core of summer. The design combines the natural scenery of the beach, the sunset, and the surfers, giving the paddle board a new meaning. With this paddle board, you can feel the heat of the beach, the natural breeze, and the passion for sports at any time.

Art Deco Collection



Cosmetic Art Printing Technology

ArtDeco Series is a new series adopting special printing technology. We integrate vitality, fantasy, abstraction, realism, exploration, adventure and other trend elements into the board, combined with our UAL technology, and finally realize a series that can integrate highly personalized patterns.

Cosmetic Art Printing (CAP) Technology is an auto printing process based on pre-designed patterns at high resolution using the best material of our board. It allows print at single colors and complicated textures and ensures color intensity and fastness to resist over time.



Long lasting



Eco-friendly



Soft Handle



Excellent adhesion



Ideal coating



Dock Ring

C3-34149
10'8"x33"x6"
325x84x15cm

CALM & EXPLORATION & SAFETY

C1-34147
10'8"x33"x6"
325x84x15cm

SIMULATION & SPIRITUAL RELAXATION

C2-34148
10'8"x33"x6"
325x84x15cm

VITALITY & EXPLORATION & SAFETY



1. High Pressure Valve.
For extreme air and water tightness.

2. EVA Foam Deck Pad.
Soft texture and full of friction against slip.

3. Thermal Bonding Inner Rail Layer.
For extra air tight seal.

4. Thermal Bonding Outer Rail Layer.
For smooth and compact bonding of all layers.

ISD(I-Drop Stitch Core).
For higher compressive and tensile strength.

6. CAP Composite Coating.
Auto printing process based on pre-designed patterns to ensure color intensity and fastness.

EVASION RANGE



275x76x13cm
9'x30"x5"



297x76x13cm
9'9"x30"x5"



335x81x13cm
11'x32"x5"

Our Evasion SUP is ideal for anyone who wishes to discover this new sport. With a width spanning between 30" and 32" depending on the model, and a thickness of 5", this SUP offers all which one is looking for to take on the calm waters of a lake for the first time.

With well-thought dimensions in width and length, all three models offer excellent stability. Once a little

more experienced, why not challenge yourself and increase your sliding speed with the 11' board. Complete for beginners and for longer rides, the Evasion can also be turned into a kayak-SUP with a seat that is fixed to the board (optional). The UAL technology and the drop-stitch concept used in these SUP make them extremely light and rigid, for optimum sliding on the water surface.



Ultimate Agile Light Technology

Specially developed for the portable boards. Extremely decrease the weight of boards to transport a single packaged board easily anywhere.

1. **High Pressure Valve.** For extreme air and water tightness.
2. **EVA Foam Deck Pad.** Soft, comfort and anti-slip texture.
3. **Thermal Bonding Inner Rail Layer.** For extra air tight seal.
4. **Thermal Bonding Outer Rail Layer.** For smooth and compact bonding of all layers.
5. **ISD(I-Drop Stitch Core).** For higher compressive and tensile strength.
6. **UAL Composite Coating.** Heavy duty reinforced PVC layer.

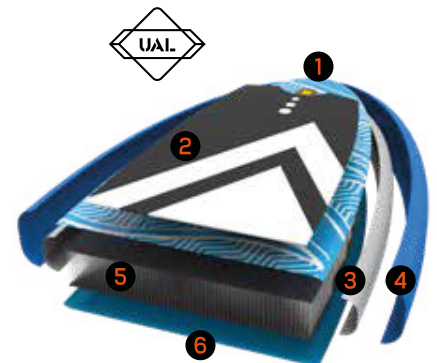

A SUP THAT LENDS ITSELF TO FIRST OUTINGS

EVASION 9'

MAX **95 KG**

DROPSTITCH LIGHTWEIGHT

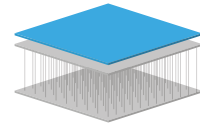

THICKNESS **13 CM**

BEGINNER

INTERMEDIATE

ADVANCED

RIDE

FITNESS

WAVE

SPEED



Dimensions	275 x 76 x 13 cm 9' x 30" x 5"
Technology	Drop Stitch Lightweight
Fins	1 removable central
Volume	194 L
Max. Weight of the rider	95 Kg
Guarantee	1 year
Ref	PB-ZE9B

Complete for beginners, the Evasion 9' can also be turned into a kayak-SUP with a seat that is fixed to the board (optional). The UAL technology and the drop-stitch concept used in these SUP make them extremely light and rigid, for optimum sliding on the water surface.

With a width at 30" and a thickness of 5", the stability of the Evasion 9' offers all which one is looking for to take on the calm waters of a lake for the first time. Its 9' length, which plays an important role in the board's stability, remains however small enough for this this board to be manoeuvred with extreme ease enabling the rider to confidently take on any turns.

All included Pack



3 sections Paddle



High pressure pump



Backpack with 2 handles



3CM KICKPAD TAIL

Better leverage and more maneuverability.



CONVERTIBLE IN KAYAK

4 D-Rings to click a kayak seat.



ELASTIC CARGO STRAPS

To secure any additional item that will make your outing even more enjoyable.



CENTRAL HANDLE + TAIL HANDLE

Neoprene lined handles ultra comfortable and easy holding.

MAX 110KG

A STABLE SUP TO GAIN IN SPEED EVASION 10'

**DROPSTITCH
LIGHTWEIGHT**

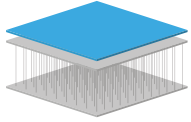

THICKNESS
13CM

BEGINNER **INTERMEDIATE** **ADVANCED**

RIDE

FITNESS

WAVE

SPEED

Dimensions	297 x 76 x 15 cm 9'9" x 30" x 5"
Technology	Drop Stitch Lightweight
Fin	1 removable central
Volume	210 L
Max. Weight of the rider	110 Kg
Guarantee	1 year
Ref	PB-ZE10B



All included Pack



3 sections Paddle



High pressure pump



Backpack with 2 handles

With a board length of 9', a more experienced rider can rely on the Evasion Deluxe to practice his/her speed and bring his/her taste for adventure even further. Its width at 30" and its thickness at 5" brings excellent stability to this board for comfortable long rides. The Evasion Deluxe can handle up to 242 lbs (110 kg),

enough to bring along a picnic, and, why not, anything one might need for a discovery walk at the docking point. The UAL technology used in this board and its 15 psi pressure when inflated give it high compactness, comparable to rigid SUP. Its 4 mm EVA non-slip central and kick pad insures the user a smooth ride.



KICKPAD TAIL

Better leverage and more maneuverability.



CONVERTIBLE IN KAYAK

4 D-Rings to click a kayak seat.



ELASTIC CARGO STRAPS

To secure any additional item that will make your outing even more enjoyable in a waterproof bag.



CENTRAL + TAIL HANDLES

Neoprene lined handle ultra comfortable and easy holding.

YOUR FREEDOM SUP EVASION 11'



MAX 122 KG

DROPSTITCH LIGHTWEIGHT

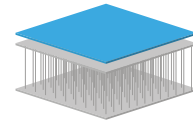

THICKNESS
13 CM

BEGINNER INTERMEDIATE ADVANCED



Dimensions	335 x 81 x 13 cm 11'x32"x6"
Technology	Drop Stitch Lightweight
Fin	1 removable central
Volume	246 L
Max. Weight of the rider	122 Kg
Guarantee	1 year
Ref	PB-ZE101B

All included Pack



3 sections Paddle



High pressure pump



Backpack with 2 handles

The Evasion Epic brings a sense of freedom thanks to its dimensions that grant this SUP great versatility. With its 11' length, this board gains in glide and speed. Its 32" width brings incomparable ease of use to the rider, who will be able to move around or shift its position without fear of toppling over. The Evasion Epic is equipped with a 4 mm non-slip EVA central

pad for the rider's comfort. The Evasion Epic has an outstanding load capacity. It can support up to 269 lbs (122 kg) for additional hiking equipment or to share a moment outside with family. The kayak seat (optional) that can be installed with the integrated d-rings, and the bungee included will be an invitation to anyone wishing to share in a moment out in the nature.



KICKPAD TAIL

Better leverage and more maneuverability.



CONVERTIBLE IN KAYAK

4 D-Rings to click a kayak seat.



ELASTIC CARGO STRAPS

to secure any additional item that will make your outing even more enjoyable in a waterproof bag.



CENTRAL + TAIL HANDLES

Neoprene lined handle ultra comfortable and easy holding.

X-RIDER RANGE



275x76x13cm
9'x30'x5"

310x81x15cm
10'2"x32"x6"

330x81x15cm
10'10"x32"x6"

365x81x15cm
12'x32"x6"

396x91x15cm
13'x36"x6"

The most popular and versatile series of ZRAY Inflatable SUPs due to fashion and attractive design. It is designed for all purposes.

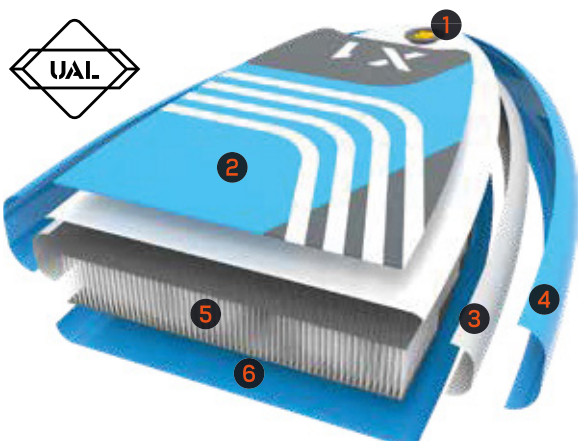
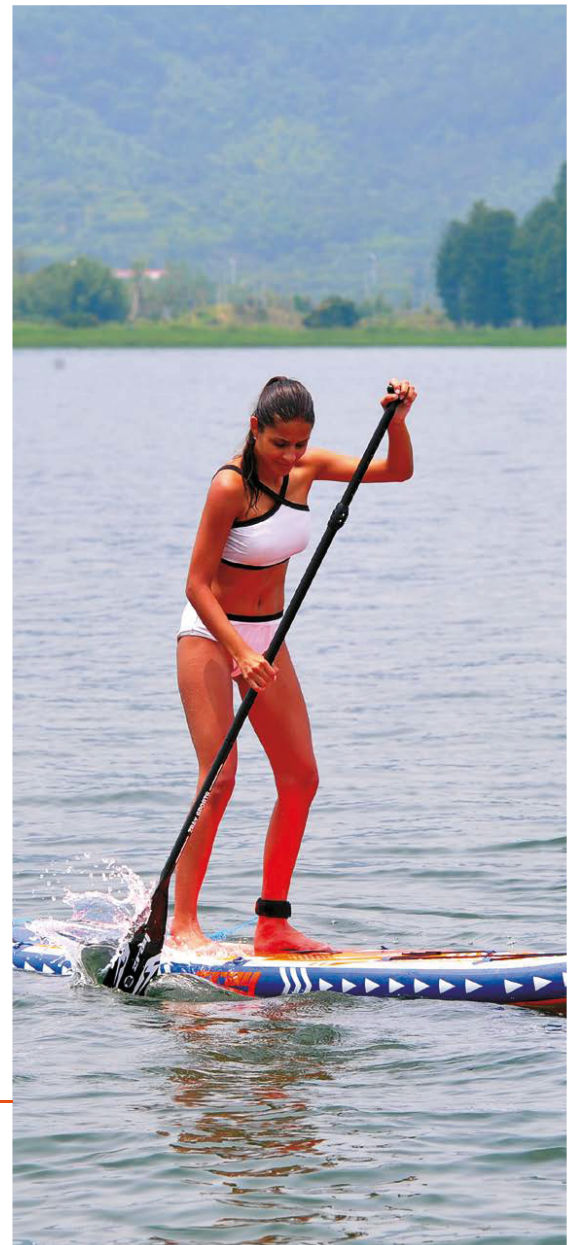

Ultimate Agile Light Technology

Specially developed for the portable boards. Extremely decrease the weight of boards to transport a single packaged board easily anywhere.

1. High Pressure Valve.

For extreme air and water tightness.

2. EVA Foam Deck Pad.

Soft, comfort and anti-slip texture.

3. Thermal Bonding Inner Rail Layer.

For extra air tight seal.

4. Thermal Bonding Outer Rail Layer.

For smooth and compact bonding of all layers.

5. ISD (I-Drop Stitch Core).

For higher compressive and tensile strength.

6. UAL Composite Coating.

Heavy duty reinforced PVC layer.

DESIGNED FOR THE YOUNG PADDLER IN MIND X-RIDER 9'

MAX 85 KG

DROPSTITCH LIGHTWEIGHT

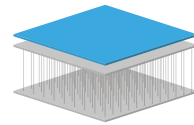

THICKNESS **13 CM**

BEGINNER INTERMEDIATE ADVANCED

RIDE

FITNESS

WAVE

SPEED



Dimensions	275 x 76 x 13 cm 9' x 30" x 5"
Technology	Drop Stitch Lightweight
Fin	1 removable central
Weight	7 Kg
Volume	167 L
Max. Weight of the rider	85 Kg
Ref	XO-34084

This Stand up Paddle is great for young paddlers wishing to practice paddling and spend quality time with the family. Its 9' length and the 30" width makes it super easy for young riders to

manoeuver their board in all conditions. They will be able to carry their fully inflated board thanks to its extreme lightweight.

All included Pack



3CM KICKPAD TAIL

Better leverage and more maneuverability.



CONVERTIBLE IN KAYAK

4 D-Rings to click a kayak seat.



ELASTIC STORAGE

The net allows you to store a waterproof bag.



CENTRAL HANDLE

Neoprene lined handle ultra comfortable and easy holding.

MAX 125 KG

DROPSTITCH LIGHTWEIGHT

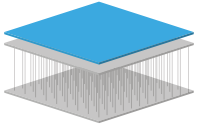

THICKNESS
15 CM

BEGINNER **INTERMEDIATE** **ADVANCED**

RIDE

FITNESS

WAVE

SPEED

Dimensions	310 x 81 x 15 cm 10'2" x 32" x 6"
Technology	Drop Stitch Lightweight
Fin	1 removable central
Weight	8,5 Kg
Volume	259 L
Max. Weight of the rider	125 Kg
Ref	XO-34085



All included Pack



The 10'2» gets a rigid shape and is very stable. It's a great board for all skill levels and conditions. Soft EVA deck pad makes it family and pet friendly. Quick inflation and deflation. When deflated, this board rolls up to a compact size with a cinch strap and fits neatly just about anywhere – trunk, closet, boat locker

or under your bed! ZRAY X-RIDER is 10'2" long and provides 32" of deck width for improved stability and balance while standing. Thanks to its 6" military grade drop stitch construction, you'll not need to worry dings, punctures or damage.



KICKPAD TAIL

Better leverage and more maneuverability.



CONVERTIBLE IN KAYAK

4 D-Rings to click a kayak seat.

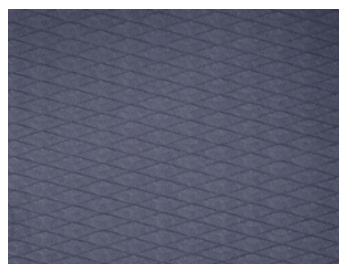

EVA MAT DIAMOND GROOVE

Soft EVA foam with Z-shaped embossing against slip.

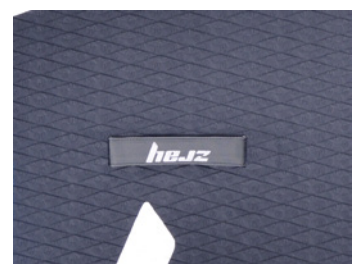

CENTRAL HANDLE

Neoprene lined handle ultra comfortable and easy holding.

THE SUPER VERSATILE SUP X-RIDER 10'10"

MAX 150 KG

**DROPSTITCH
LIGHTWEIGHT**

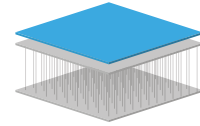

THICKNESS
15 CM

BEGINNER **INTERMEDIATE** **ADVANCED**

RIDE ██████████

FITNESS ██████████

WAVE ██████████

SPEED ██████████

Dimensions	330 x 81 x 15 cm 10'10" x 32" x 6"
Technology	Drop Stitch Lightweight
Fin	1 removable central
Weight	9.6Kg
Volume	293 L
Max. Weight of the rider	150 Kg
Ref	XO-34086



With all features of X-RIDER, added benefits of X-RIDER DELUXE include: 10'10" x 32" x 6" you can gain much more speed and fun while paddling. A higher volume that improves the capacity. Indeed, the weight capacity is 150kg/330lbs,

25kg/55lbs higher than X-RIDER. You can take a small passenger/pet or extra cargo on board easily, which is why it's popular with family paddlers and those with furry friends.

All included Pack



KICKPAD TAIL

Better leverage and more maneuverability.



CONVERTIBLE IN KAYAK

4 D-Rings to click a kayak seat.

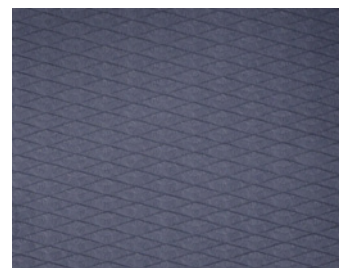

EVA MAT DIAMOND GROOVE

Soft EVA foam with Z-shaped embossing against slip.



CENTRAL HANDLE

Neoprene lined handle ultra comfortable and easy holding.

MAX 162 KG INCREASED CAPACITY AND STABILITY

X-RIDER 12'

DROPSTITCH LIGHTWEIGHT

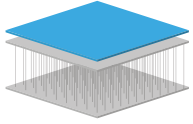

THICKNESS
15 CM

BEGINNER INTERMEDIATE ADVANCED

RIDE

FITNESS

WAVE

SPEED



Dimensions	365 x 81 x 15 cm 12'x32"x6"
Technology	Drop Stitch Lightweight
Fin	1 removable central
Weight	9,4 Kg
Volume	324 L
Max. Weight of the rider	162 Kg
Ref	XO-34087

All included Pack



3 sections Paddle Double action pump Backpack with 2 handles

Coiled leash Repair Kit Pump adaptor

With all features of X-RIDER DELUXE, added benefits of X-RIDER EPIC include: 12' x 32" x 6". With 14" longer than X-RIDER DELUXE, you can gain much more speed and fun while paddling. Same width than X-RIDER DELUXE results in enhanced stability and balance, allowing you to walk around and change your position

without fear of flipping over. The weight capacity is 162kg/357lbs, 17kg/37lbs higher than X-RIDER DELUXE. You can take an additional passenger/pet or extra cargo on board easily, which is why it's popular with family paddlers and those with furry friends.



KICKPAD TAIL

Better leverage and more maneuverability.



CONVERTIBLE IN KAYAK

4 D-Rings to click a kayak seat.

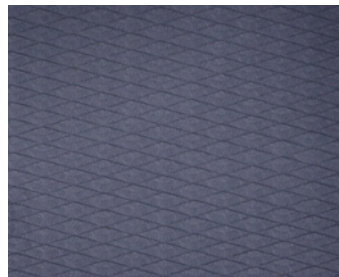

EVA DIAMOND GROOVE

Soft EVA foam with Z-shaped embossing against slip.



CENTRAL HANDLE

Neoprene lined handle ultra comfortable and easy holding.

FAMILY OUTDOOR ACTIVITIES AND SUPER FUN X-RIDER 13'

MAX 220KG

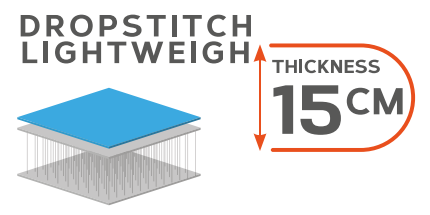

BEGINNER **INTERMEDIATE** **ADVANCED**



Dimensions	396 x 91 x 15 cm 13'x36"x6"
Technology	Drop Stitch Lightweight
Fins	2 fixed + 1 removable central
Weight	11,2 Kg
Volume	440 L
Max. Weight of the rider	220 Kg
Ref	X5-34088

All included Pack



Super fun, this inflatable board is developed for hitting the water for a family. Not many outdoor activities that the whole family can join in. ZRAY X-RIDER XL extends the family fun to the next level with its xtraordinary length and width. Designed for 2 adults plus 1 child, this bid board is absolutely a platform for family bonding.

Thanks to its super size : 13' x 36" x 6", this monster board can stand up to the toughest of challenges and conditions with a wide deck and tail making it extremely stable.



KICKPAD TAIL
Better leverage and more maneuverability.



CONVERTIBLE IN KAYAK
4 D-Rings to click a kayak seat.



EVA MAT DIAMOND GROOVE
Soft EVA foam with Z-shaped embossing against slip.

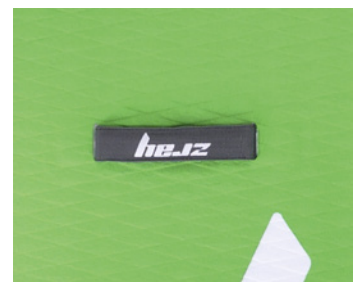

4 HANDLES ON SIDES
Neoprene lined handles ultra comfortable and easy holding.

FURY COLLECTION



315x84x15cm
10'4"x33"x6"

335x84x15cm
11'x33"x6"

365x84x15cm
12'x33"x6"



Balanced Anti-bending Motility Technology

A epochal innovation for the construction of our performance boards. We develop it to keep the balance between stiffness and weight of boards.

- 1. High Pressure Valve :** For extreme air and water tightness
- 2. Eva Foam Deck Pad :** Soft texture and full of friction against slip
- 3. Thermal Bonding Inner Rail Layer :** For extra air tight seal
- 4. Thermal Bonding Outer Rail Layer :** For smooth and compact bonding of all layers
- 5. HDDS(HD I-Drop Stitch Core) :** For maximum compressive and tensile strength
- 6. BAM Composite Coating :** Machine-processed adhesive layer against blister and wrinkle
- 7. Double Chamber Structure :** The second air chamber for extra safety and rigidity

PERFORMANCE, EXPLORER & CRUISING

The longer length gives a fast and easy glide without compromising stability. The wider nose and squarer tail make the Touring boards more stable, especially for harsh conditions like side chop and moderate winds. V outlines introduce a new sporty design, meant for fast cruising. Double cargo systems make paddlers able to carry much more equipment.

Key Feature

- BAM & DCS technology
- Patented double chamber structure. Conform to ISO6185.
- 6" (15cm) drop stitch core material.
- Triple bottom panel fins.
- Stainless steel d-rings on the deck and at the tail.
- Optimal air pressure up to 15 psi.



2 fixed & 1 central fins



Elastic Cargo Bungees



Deck Pad



Built-in mast foot for windsurfing option.



Dock Ring



Soft Handle

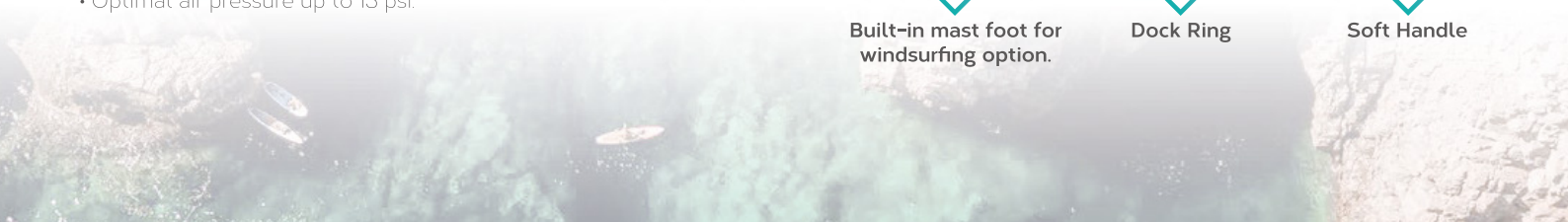

FURY 10'



315 x 84 x 15 cm
10'4" x 33" x 6" F1-34081

All included Pack



MAX **122 KG**

FUSION
DOUBLE
LAYER

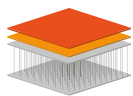

THICKNESS
15 CM

FURY 11'



335 x 84 x 15 cm
11'x33"x6" F2-34082

All included Pack



MAX **142 KG**

FUSION
DOUBLE
LAYER

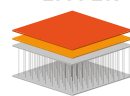

THICKNESS
15 CM

FURY 12'



365 x 84 x 15 cm
12'x33"x6" PB-ZF4

All included Pack



MAX **154 KG**

DOUBLE LAYER
+ DOUBLE
CHAMBER



THICKNESS
15 CM



DUAL COLLECTION

DUAL 10'



RIDE 
 FITNESS 
 WAVE 
 SPEED 

305 x 81 x 15 cm
10'x32"x6"

D1-37639

All included Pack



DUAL DELUXE 10'8"



RIDE 
 FITNESS 
 WAVE 
 SPEED 

325 x 81 x 15 cm
10'8"x32"x6"

D2-37640

All included Pack



Its patented Double Chamber technology enhancing the board stiffness by 30% optimizes further the DUAL's gliding capacity. The interior chamber that occupies 50% of the board surface has been integrated in such a way that it acts as a keel and improves the DUAL's stability and ensures the paddler's safety in case of board eakage. With its bright colors, the DUAL stands out not only by the quality of its material, but also with its modern design.

WINDSURF COLLECTION

WINDSURF 10'



RIDE 
 FITNESS 
 WAVE 
 SPEED 

305 x 81 x 15 cm
10'x32"x6"

W1-37336

All included Pack



WINDSURF 10'6"



RIDE 
 FITNESS 
 WAVE 
 SPEED 

325 x 81 x 15 cm
10'8"x32"x6"

W2-37337

All included Pack



Windsurfing has been designed to be as practical as possible as both SUP and windsurf board. The rig back fits as deck cargo so that you can paddle off one way and return under sail power. The short and wide design provides first time windsurfers stability and ease of maneuverability. As soon as you master the basics of windsurfing, the boards instantly offer "Fun Board" feeling. It feels fast, fun, and sporty.



RACING COLLECTION



381x76x15cm
12'6"x30"x6"

426x71x15cm
14'x28"x6"

SPEED & EXPERIENCED & RACER

A perfect shape for pure performance. The sporty, narrow outline guarantees long and effortless touring, great directional stability, and speed runs. Premium board structure with first quality drop stitch and military grade double layer PVC generates extraordinarily, stiffness and rigidity.

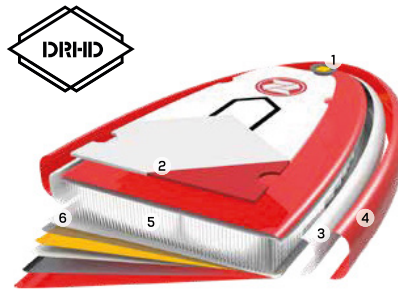

Duplex Rigid Heavy Duty Technology

A premium construction especially designed for racing lines. It provides an outstanding durability/price/performance ratio with its multilayer coatings.

1. **High Pressure Valve.** For extreme air and water tightness.
2. **EVA Foam Deck Pad.** Soft, comfort and anti-slip texture.
3. **Thermal Bonding Inner Rail Layer.** For extra air tight seal.
4. **Thermal Bonding Outer Rail Layer.** For smooth and compact bonding of all layers.
5. **ISD(I-Drop Stitch Core).** For higher compressive and tensile strength.
6. **DR HD Composite Coating.** HD laminated reinforced PVC layer.



US Fin



Dock Ring



Elastic Cargo Bungee



Soft Handle



Deck Pad

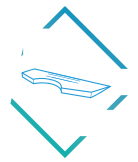

Tail Kick

RAPID R1 12'6"



- RIDE
- FITNESS
- WAVE
- SPEED

381 x 76 x 15 cm
12'6"x30"x6"

R1-37637

All included Pack



RAPID R2 14'



- RIDE
- FITNESS
- WAVE
- SPEED

427 x 71 x 15 cm
14'x28"x6"

R2-37638

All included Pack



ZRAY® AQUAJET

EVOLUTION

The new style for enjoying outdoors.

Zray AquaJet is an electric motor to save your effort and energy in a long sup journey. Explore and enjoy a new way of paddle boarding. Streamline body design and 360° water intake grille for optimal efficiency. Adaptable to all ZRAY SUPs and kayaks. Bluetooth remote control with waterproof watch to forward, backward and adjust speed level.



Remote Control

Easy to install and great portability



Smart Design

Streamline body design and 360° water intake grille for optimal efficiency



Wireless Control

Bluetooth remote control with waterproof watch to forward, reverse and curve



High Compatibility

Adaptable to all ZRAY SUPs and kayaks.



Enjoy E-SUP

Replace the fin with AquaJet. Get an electric boost up to 7km/h

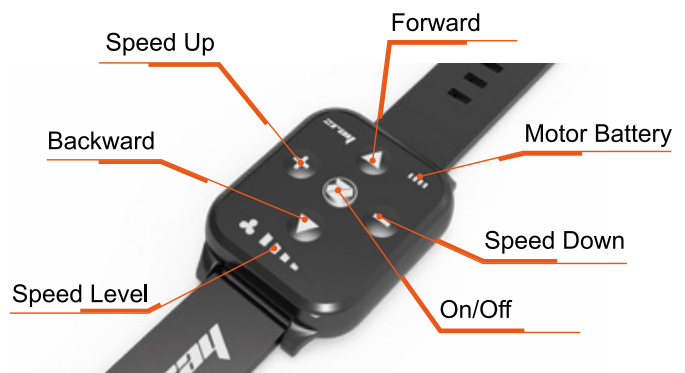

NET WEIGHT



5.5lbs(2.5kg)

INSTALLATION



Slide-in fin

RUNTIME



60 minutes maximum

SPEED



up to 7 km/h

PORTABILITY



Remote Control

KAYAK

ZRAY kayak comes in a range of different shapes and sizes to cater for all your expectations. With innovative, aesthetic, stable design, ZRAY kayak delivers excellent sensations and satisfaction. Whether it's serious exploring, having fun at the beach, hooking fish, or taking them travelling, we hope you'll enjoy the

DRIFT

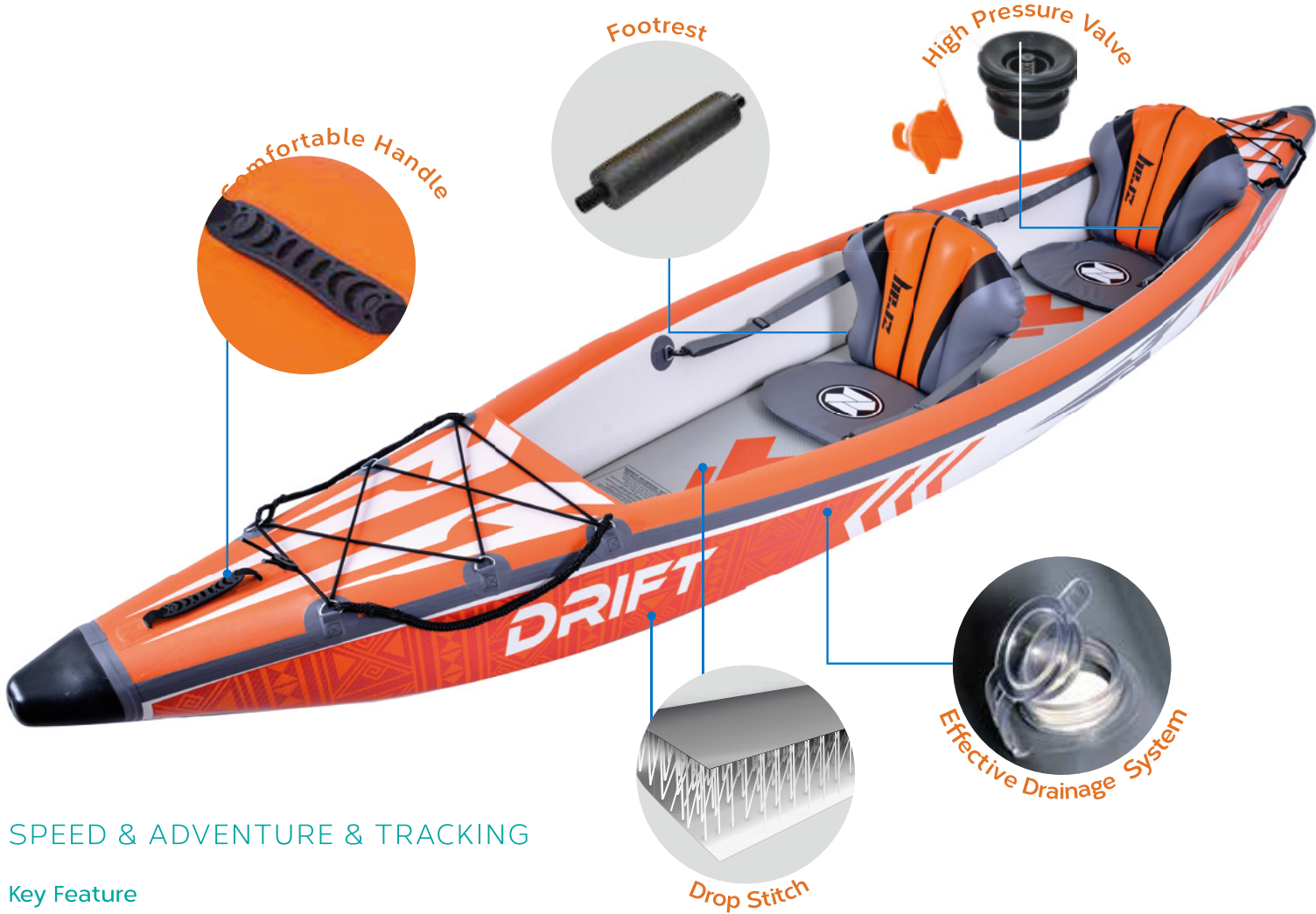

SPEED & ADVENTURE & TRACKING

Key Feature

- Fully constructed of high pressure drop stitch.
- Wide shape for excellent stability.
- High pressure valve for easy inflation and deflation.
- Removable fin for directional stability.
- Effective drainage system.

Item No. 37641

Inflated	Air Chamber	Capacity (person)	Max.load Weight (lbs/kgs)	Hull Type	Floor Type	GW (lbs/Kgs)	Case Pack (cbm/pkg)
426x81cm (14'x32")	3	2 Adults	485/220	Drop Stitch	Drop Stitch	50/22.6	0.126/1

PACKAGE INCLUDES





Zray[®]
PADDLE with PASSION...

TORTUGA

MIX OF PORTABILITY AND RIGIDITY

Key Feature

- Construction with heavy laminated tube and drop stitch floor.
- Wide shape for excellent stability.
- High pressure valve for easy inflation and deflation.
- Backpack system for easy storage and transport.
- Convenient handle at the bow and stern with spray deck.
- Removable fin for directional stability.
- Adjustable footrests.

Item No. 34089

Inflated	Air Chamber	Capacity (person)	Max.load Weight (lbs/kgs)	Hull Type	Floor Type	GW (lbs/Kgs)	Case Pack (cbm/pkg)
386x86cm (152"x34")	3	2 Adults	374/170	Laminated PVC	Drop Stitch	50/22.6	0.138/1

PACKAGE INCLUDES





PACKAGE INCLUDES



ST. CROIX

LIGHT & LOW-MAINTENANCE & EASY-HANDLING

Key Feature

- Construction with thick and durable PVC material.
- 2 main chambers on hull for extra security.
- Quick inflation and deflation screw valve.
- All around grab rope.
- 1 air chamber inflatable floor for comfort and rigidity.
- Durable oar locks and oar holders(2 person).
- 2 seat cushion included(2 person).

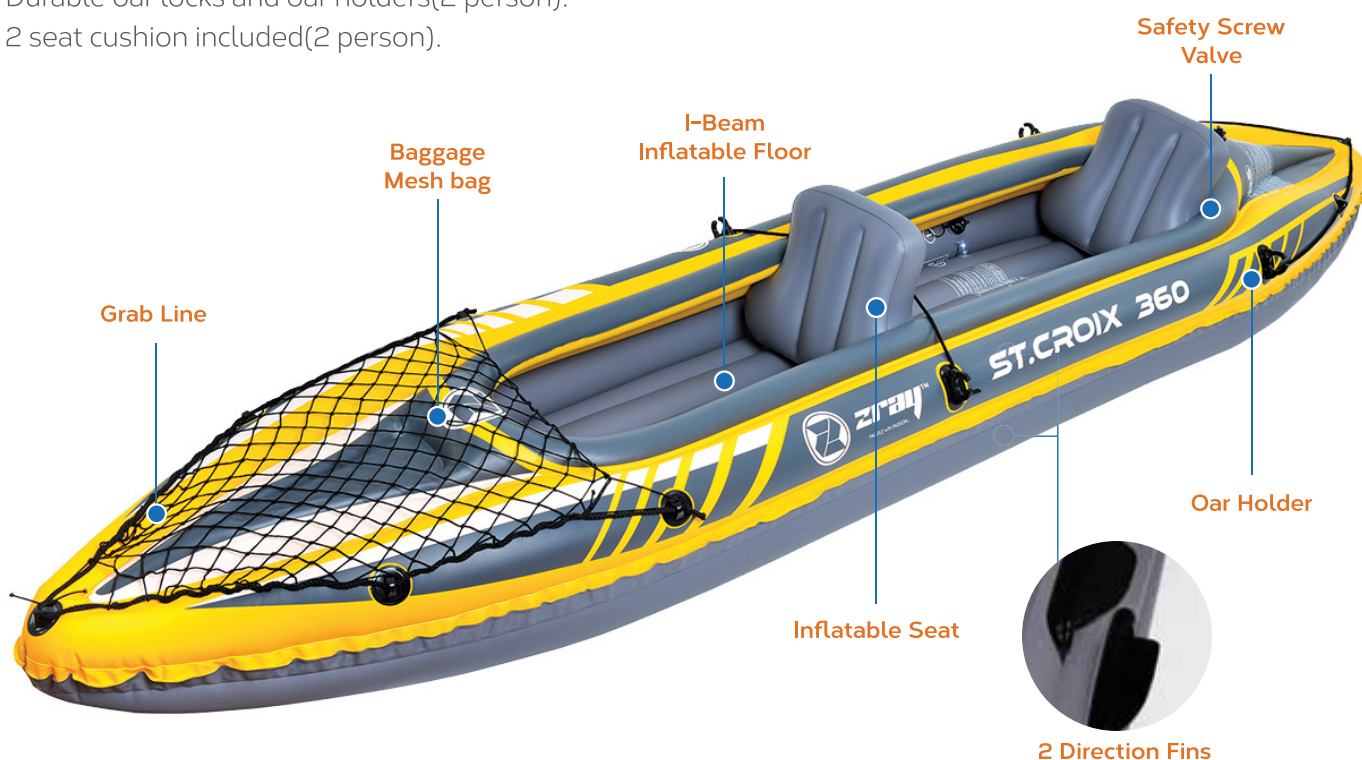

Item No. 37326

Inflated	Air Chamber	Capacity (person)	Max.load Weight (lbs/kgs)	Hull Type	Floor Type	GW (lbs/Kgs)	Case Pack (cbm/pkg)
350x78cm (138"x31")	3	2 Adults	352/160	PVC	PVC	295/133	0.076/1



BODYBOARD COLLECTION



MARINE

B1-34154

48"x28"x4"
(122x71x10cm)

GRAIN

B2-34155

48"x28"x4"
(122x71x10cm)

FLOWER

B3-34156

48"x28"x4"
(122x71x10cm)

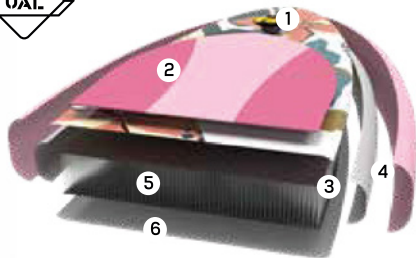

Ultimate Agile Light Technology

Specially developed for the portable boards. Extremely decrease the weight of boards to transport a single packaged board easily anywhere.

1. **High Pressure Valve.** For extreme air and water tightness.
2. **EVA Foam Deck Pad.** Soft, comfort and anti-slip texture.
3. **Thermal Bonding Inner Rail Layer.** For extra air tight seal.
4. **Thermal Bonding Outer Rail Layer.** For smooth and compact bonding of all layers.
5. **ISD(I-Drop Stitch Core).** For higher compressive and tensile strength.
6. **U.A.L Composite Coating.** Heavy duty reinforced PVC layer.

PACKAGE INCLUDES





AIRDOCK

ALL-IN-ONE & GROUP & PORTABILITY

AirDock is all-in-one swim platform, outdoor yoga platform, and portable dock. Its super simplicity, high stability, and incredible durability make it the most feature-rich than ever. Take it to the house by the lake, make it float on the beach, use it as a yoga platform, bundle it together to increase your real estate on the water without compromising storage space. Endless use if you can imagine.

34161 10'x6'x6" (305x183x15cm)

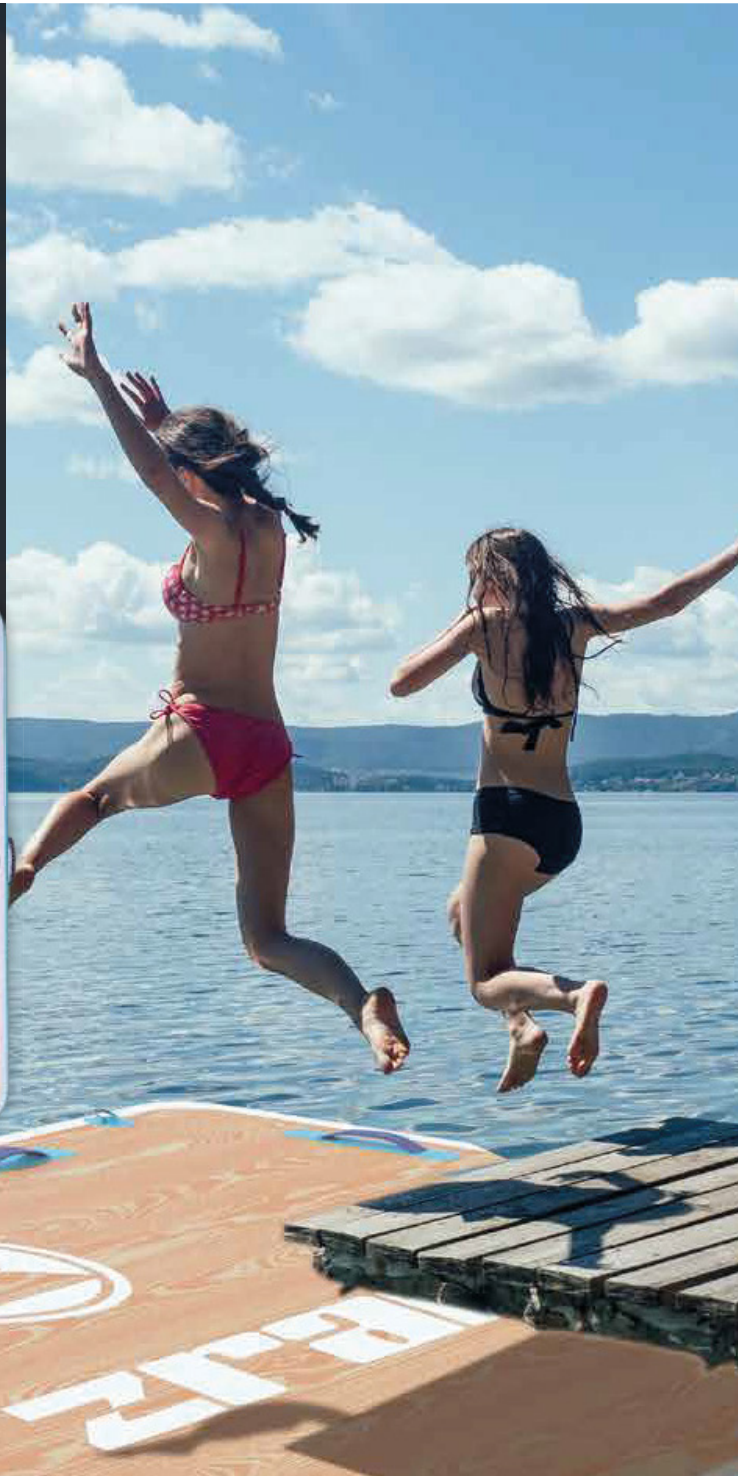

PACKAGE INCLUDES



Long lasting



Eco-friendly



Ideal coating



Excellent adhesion



Soft Handle



Dock Ring



Tropical Collection



ELLE 10'4''

Dimensions
315 x 79 cm
10'4" x 31"

Thickness
13cm // 5"

LUI 10'8''

Dimensions
325 x 84 cm
10'8" x 34"

Thickness
15cm // 6"

Technology
Drop-Stitch
Triple Layer Stringer

Suncruise Collection



SC 10'2''

Dimensions
310 x 84 cm
10'2" x 33"

Thickness
15cm // 6"

Technology
Drop-Stitch
Double layer fusion

SC 11'2''

Dimensions
340 x 84 cm
11'2" x 33"

Thickness
15cm // 6"

Technology
Drop-Stitch
Double layer fusion

SC 12'

Dimensions
365 x 86 cm
12' x 34"

Thickness
15cm // 6"

Technology
Drop-Stitch
Double layer fusion

The Skiffo Family

The Skiffo range of Stand-Up-Paddles has been designed and perfected to create memorable outings as a duo, with family or with friends.

TECHNOLOGY AND AESTHETICS

From a standpoint technology, the Skiffo boards have nothing to envy to those preferred by the professionals. The brand leaves nothing to chance: the **3 Suncruise models** as all benefit from a double layer thermally bonded, and the drop-stitch method has been applied to all SUPs. These tested technologies maximize the boards' compactness and rigidity, improving the Stand-Up-Paddle gliding capacity.

Two models are especially suited to beginners and recreative usage:

Elle, Lui - for which Skiffo has created very distinctive trendy personalities. Elle and Lui, with bright pink and blue colours, invite to an outing as a duo.

A PRACTICAL STAND-UP-PADDLE

Once deflated, these SUPs and all equipment are easily put away in their bag that can be stored in a trunk, a closet or even under the bed. For an easy outing, the Skiffo Stand-Up-Paddles are supplied with all necessary equipment: bag on wheels, high pressure double action pump, paddle, foot leash and repair kit.



@davidbenezech



@dogs_on_trip



@Ladlilu



@lucuellou



@kahroline_63



@sophiegrzn



Skiffo Elle & Lui

DROP STITCH | TRIPLE LAYER STRINGER

With the Drop Stitch, the interior of the SUP is made up of thousands of polyester threads that stretch with the pressure of the inflated board providing better resistance to compression and traction. The SUP thus gains in rigidity.

Skiffo has developed an innovative exclusive technology for its ELLE and LUI range. A double-layered stringer connects the nose to the tail, on the deck and the bottom of the board. This gains more rigidity without compromising the lightness of the SUP. The digitally printed stringer gives the Skiffo ELLE and LUI a high quality colorful finish.



DROP STITCH
High density
drop-stitch threads



EVA PADS
4mm non-slip
eva pad



REINFORCED PVC
High Quality PVC
conception



PSI INFLATION
High pressure
PSI inflation



UV RESISTANCE
Reinforced UV
Resistance



PREMIUM VALVE
Premium inflation
valve



Elle 10'4"

SKIFFO FOR HER

MANOEUVRABILITY 
 STABILITY 
 SPEED 

Beginner **Intermediate** **Advanced**

Dimensions	315 x 79 cm / 10'4" x 31"
Thickness	13cm / 5"
Technology	Drop-Stitch / Triple Layer Stringer
Max. Charge	105kg
Fins	1 central slide-in
Ref	PB-SXY104C

-  **Max. Charge**
105kg
-  **Technology**
Dropstich
Triple layer Stringer
-  **Thickness**
13cm

FEMININ DESIGN AND DIMENSIONS.

Designed in a bright pink colour, the Skiffo Elle invites you to embrace your passion from a female perspective and indulge in it freely. The length and width of the Skiffo Elle - 315 cm x 79 cm - have been designed precisely for the female body type which is generally narrower at the shoulders.



All included Pack



CARGO STRAPS
Make the fun last by loading a waterproof bag filled with food and drink in the front of your board.



15 PSI PRESSURE VALVE
Skiffo SUPs are equipped with a high pressure push/pull technology valve guaranteeing extreme air and water tightness.



D-RINGS KAYAK SEAT
Convert your SUP into a kayak by attaching a seat (optional) to the 4 side d-rings.



EVA CENTRAL AND KICK PADS
Skiffo SUPs are equipped with a central pad in EVA foam with a comfort thickness of 4 mm. A kick pad of the same quality, raised by 5 cm, complements this SUP to facilitate manoeuvrability

Lui 10'8"

SKIFFO FOR HIM

MANOEUVRABILITY



STABILITY



SPEED



Beginner

Intermediate

Advanced

Dimensions	325 x 84 cm / 10'8" x 33"
Thickness	15 cm / 6"
Technology	Drop-Stitch / Triple Layer Stringer
Max. Charge	135 kg
Fins	1 central slide-in
Ref	PB-SXY108C



Max. Charge
135kg



Technology
Dropstich
Triple layer Stringer



Thickness
15cm

A SUP THAT REVEALS ITS TRUE STRIPES FROM THE OUTSET.

A dynamic combination of blues that reminds the true masculine side of this SUP of 325 cm in length. It quickly gains in gliding speed thanks to its high rigidity. The Skiffo LUI benefits from the Drop Stitch concept that optimizes the compactness of the board under pressure. A stringer running the length of the SUP reinforces the rigidity of a triple layer. You will enjoy a SUP of exceptional buoyancy for a more than surprising gliding experience.



All included Pack



CARGO STRAPS

Make the fun last by loading a waterproof bag filled with food and drink in the front of your board.



15 PSI PRESSURE VALVE

Skiffo SUPs are equipped with a high pressure push/pull technology valve guaranteeing extreme air and water tightness.



D-RINGS KAYAK SEAT

Convert your SUP into a kayak by attaching a seat (optional) to the 4 side d-rings.



EVA CENTRAL AND KICK PADS

Skiffo SUPs are equipped with a central pad in EVA foam with a comfort thickness of 4 mm. A kick pad of the same quality, raised by 5 cm, complements this SUP to facilitate manoeuvrability



SunCruise Collection

SunCruise Technology

DROP-STITCH | DOUBLE LAYER FUSION

Our Skiffo SUN CRUISE takes it up a notch and opt for cutting-edge Double Layer Fusion technology. A second layer of reinforced PVC is thermally welded to the basic Drop-Stitch construction.

This technology reinforces the Drop-Stitch design, which increases the rigidity of the board from the inside: thousands of high-density polyester fibers connect the top and bottom layers of the board to optimize the compactness and lightness of the whole board.

Inflated under high pressure (15 Psi), the SUNCRUISE SUPs guarantee exceptional rigidity and preserve the initial shape of the board in all conditions. The rail of the board is also lined with a second layer of PVC to prevent any type deformation.

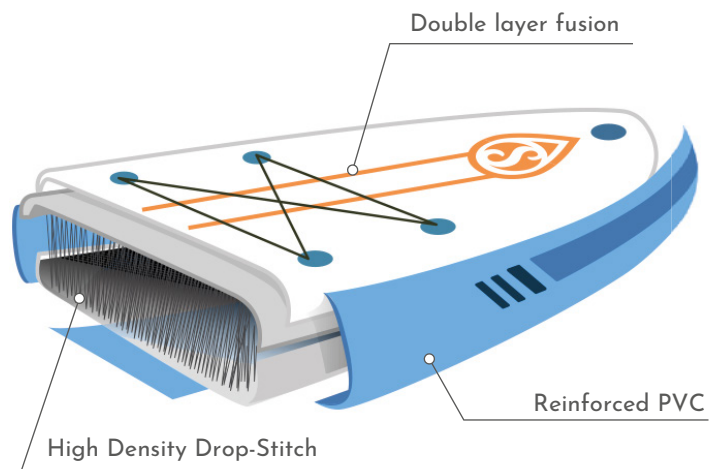

DROP STITCH
High density drop-stitch threads



EVA PADS
4mm non-slip eva pad



REINFORCED PVC
High Quality PVC conception



PSI INFLATION
High pressure PSI inflation



UV RESISTANCE
Reinforced UV Resistance



PREMIUM VALVE
Premium inflation valve



Suncruise 10'2"

THE DISCOVERY SUP

MANOEUVRABILITY



STABILITY



SPEED



Beginner
 Intermediate
 Advanced

Dimensions	310 x 84 cm / 10'2" x 33"
Thickness	15cm / 6"
Technology	Drop-Stitch / Double layer fusion
Max. Charge	110 kg
Fins	1 central slide-in
Ref	PB-SSC102C

- Max. Charge**
110 kg
- Technology**
Dropstich
Double layer fusion
- Thickness**
15 cm

AN ALL-RIDERS SUP.

In all its versatility, the Suncruise 10'2 SUP is suitable for many types of users wishing to discover this board sport. The 310cm length and 84cm width make the Suncruise 10'2 a stable SUP that offers a platform wide enough to feel a good balance. Both small and young users will enjoy the dimensions of this SUP made for outings on calm waters.



CARGO STRAPS

Make the fun last by loading a waterproof bag filled with food and drink in the front of your board.



15 PSI PRESSURE VALVE

Skiffo SUPs are equipped with a high pressure push/pull technology valve guaranteeing extreme air and water tightness.



D-RINGS KAYAK SEAT

Convert your SUP into a kayak by attaching a seat (optional) to the 4 side d-rings.



EVA CENTRAL AND KICK PADS

Skiffo SUPs are equipped with a central pad in EVA foam with a comfort thickness of 4 mm. A kick pad of the same quality, raised by 5 cm, complements this SUP to facilitate manoeuvrability



Suncruise 11'2"

THE LONG DISTANCE SUP

MANOEUVRABILITY 
 STABILITY 
 SPEED 

Beginner Intermediate Advanced

Dimensions	340 x 84 cm / 11'2" x 33"
Thickness	15cm / 6"
Technology	Drop-Stitch / Double layer fusion
Max. Charge	150 kg
Fins	1 central slide-in
Ref	PB-SSC112C



Max. Charge
150 kg



Technology
Dropstitch
Double layer fusion



Thickness
15 cm

INCREASED BUOYANCY, IMPROVED GLIDE.

You will find in the Suncruise 11'2" dimensions that call for better gliding from the first paddling strokes. With its 340 cm length, this speed SUP will nonetheless surprise by its great stability which it gains through a width of 84 cm and two advanced construction technologies that increase its stiffness by 30%.



All included Pack



CARGO STRAPS

Make the fun last by loading a waterproof bag filled with food and drink in the front of your board.



15 PSI PRESSURE VALVE

Skiffo SUPs are equipped with a high pressure push/pull technology valve guaranteeing extreme air and water tightness.



D-RINGS KAYAK SEAT

Convert your SUP into a kayak by attaching a seat (optional) to the 4 side d-rings.



EVA CENTRAL AND KICK PADS

Skiffo SUPs are equipped with a central pad in EVA foam with a comfort thickness of 4 mm. A kick pad of the same quality, raised by 5 cm, complements this SUP to facilitate manoeuvrability

Suncruise 12'

THE FAMILY SUP

MANOEUVRABILITY



STABILITY



SPEED



Beginner

Intermediate

Advanced

Dimensions	365 x 86 cm / 12' x 34"
Thickness	15cm / 6"
Technology	Drop-Stitch / Double layer fusion
Max. Charge	165 kg
Fins	1 central slide-in
Ref	PB-SSC120C



Max. Charge
165 kg



Technology
Dropstich
Double layer fusion



Thickness
15 cm

REAL FAMILY SUP.

The SunCruise 12", its 365cm long, 15cm thick and 165kg capacity, easily accommodates two adults and even the companion dog. For this, 5 neoprene handles at the front, center and back of the board to secure the passengers and a "bungee" elastic to carry light equipment and, why not, a picnic.



All included Pack



CARGO STRAPS

Make the fun last by loading a waterproof bag filled with food and drink in the front of your board.



15 PSI PRESSURE VALVE

Skiffo SUPs are equipped with a high pressure push/pull technology valve guaranteeing extreme air and water tightness.



D-RINGS KAYAK SEAT

Convert your SUP into a kayak by attaching a seat (optional) to the 4 side d-rings.



EVA CENTRAL AND KICK PADS

Skiffo SUPs are equipped with a central pad in EVA foam with a comfort thickness of 4 mm. A kick pad of the same quality, raised by 5 cm, complements this SUP to facilitate manoeuvrability

Sea Scooter

Sea Side



Dimensions	53 x 21 x 17 cm
Speed	3 Niv up to 1,5m/s
Temp working	-10°C / 45°C
Depth	30m
Batterie life	35 minutes
Charge time	4 hours

REVEAL THE SECRETS OF THE UNDERWORLD

Our sea scooter SEASIDE invites you to propel yourself and discover new horizons and depths. The full-face snorkel mask included with your sea scooter will be your best partner in your water expeditions.

With a speed going up to 3 miles per hour, you will have plenty of time to amaze over the wonders of the aquatic world for a whole 35 minutes and even a full hour. Whether you choose a cold or a tropical destination, remember to take your Seaside along as it handles water temperature from -10°C to 40°C. A matching waterproof bag is included.

Equip yourself with a camera and make sure you create the best memories ever: the integrated mounting system will easily accommodate any action camera.



FULLY EQUIPPED

To make your adventure complete, the Seaside is provided with its own waterproof bag and an ergonomical full face snorkel mask.



CAMERA SUPPORT

Memories are best shared with closed ones. The Seaside includes an integrated mounting system that support any standard action camera that will capture your best moments.



GREAT AUTONOMY

With a fully charged battery, enjoy your water sightseeing for a whole 35 minutes. Go further with the 2 battery model and enjoy a full 1-hour ride.

CARBON SPRINT

Dimensions	From 170 to 215cm
Technology	Fiber glass + carbon layer
Number of sections	3 sections
Weight	750 - 800 gr
Shaft	FG + carbon layer
Blade	Fiber glass
Float	Yes
Adjustable	Yes

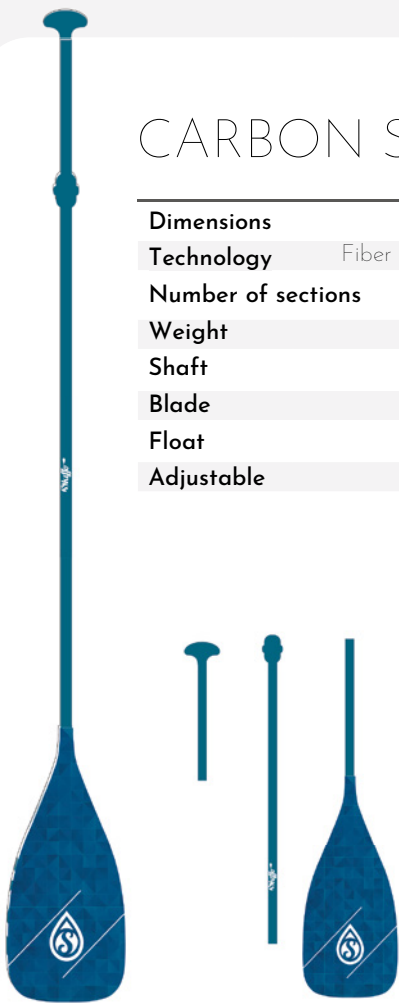

CARBON ZOOM

Dimensions	From 170 to 215cm
Technology	30% carbon 70% FG
Number of sections	3 sections
Weight	650 - 700 gr
Shaft	30% carbon 70% FG
Blade	Fiber glass
Float	Yes
Adjustable	Yes

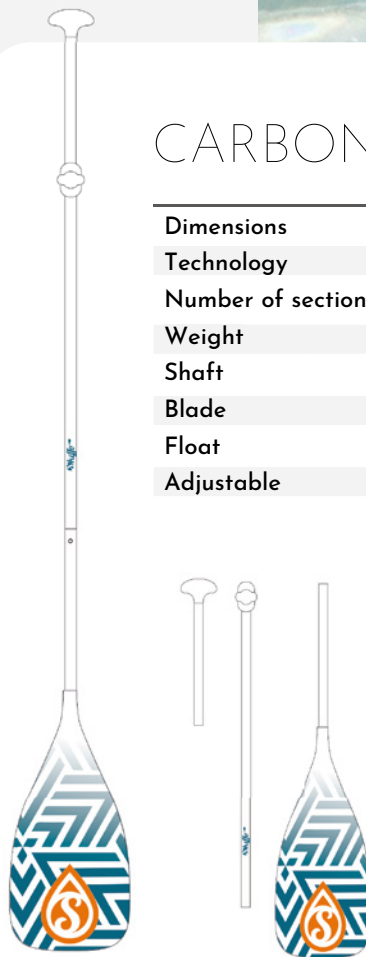

ELITE CARBON

Dimensions	From 165 to 215cm
Technology	100% Carbon
Number of sections	3 sections
Weight	< 630gr
Shaft	100% Carbon
Blade	100% Carbon
Float	Yes
Adjustable	Yes



Accessories



LEASH

Dimensions	10' // 3m étiré
Diameter	8mm
Leash	Coiled



DECKBAG

Capacity	22L
Loading bungee	Yes
Material	TPU

- Waterproof



NEW ISUP

ISUP COLLECTION



WING

ACCESSORIES





WATTSUP

EXPERIENCES TO BE SHARED



The WattSup brand is designed for the public at large and offers all a beginner is requiring to start exploring the wonders of water gliding from the youngest age.

A complete range that adapts itself to small frames, female body shape, solitary riders and those who prefer to share fun time on the water with friends and family.

STURDIER THICKER BOARDS

WattSup marks the end of the 10cm thick "entry-level" boards by offering riders a selection of modern, quality and affordable Stand-Up-Paddles. These SUPs benefit however from the drop-stitch concept, which increase the board rigidity by 40% when inflated, and gain exceptional floating capacity as well as unparalleled quality of glide.

DISCREET YET DISTINCTIVE

From an aesthetics point of view, each WattSup Stand-Up-Paddle reflects its own personality, through distinctive yet discreet colours.

The Wattsup SUPs are equipped with 4 D-rings to add a kayak seat (on option) and a kick pad for easier manoeuvring. They are all supplied as a complete package with paddle, foot leash, high pressure pump, repair kit and carry bag.

WattSup makes it easy and affordable to take the plunge and explore the wonders of nature paddling!

@life_of_franksxu

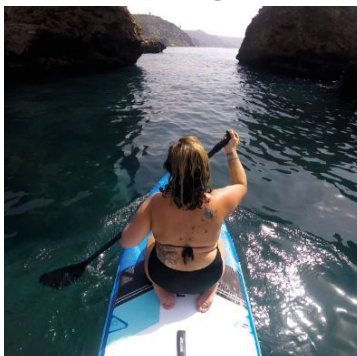

@a.yzet



@alfredo_mangione

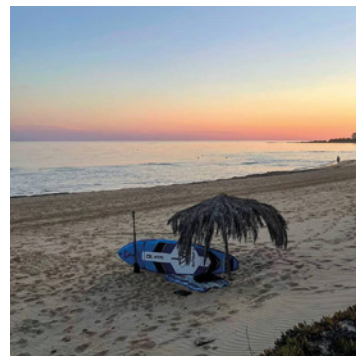

@chloedardizzone

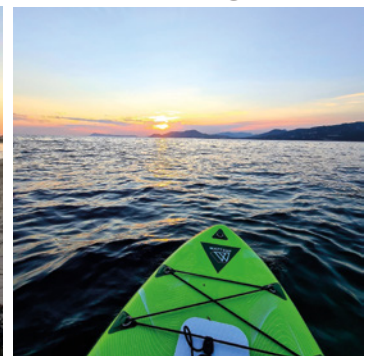

@marinapanyvino



@mattyorkbo9



@czerwonakomnata.pl



@d.e.n.i.s.a.i.z



NEW ISUP EXPERIENCES

ISup was born out of a passion for water, adventure and technologies. This range of all-round stand-up-paddles surprises by its most advanced technologies that result in boards that will accompany any adventure seeker wishing to discover the furthest lakes and shores.

From an aesthetic point of view, the ISup displays a refined modern look with a subtle play of modern teal and chartreuse yellow.

RANGE MAIN FEATURES

Studied dimensions

The ISup range comprises stand-up paddles all over 3 meters long to offer the rider exhilarating rides with a width comfortable enough to manoeuvre the board with ease. On flat waters on a lake or along sea shores, the ISups remain true to their personality wanting to always go further.

Versatility

Everything has been thought to make the ISup range an extremely versatile one. 4 d-rings to which one can attach a kayak seat (optional) as well as elastic cargo straps to bring along small equipment and a picnic. Versatility also in its capacity to be easily manoeuvred thanks to non-slip EVA foam pad strategically placed on the main part of the board and at the back as a kick pad.

Exceptional glide

All the stand-up ISup paddles claim a 15 cm thickness. Extra-rigid dropstitch technology has been applied to all four stand-up-paddles. Important features that optimizes flottability and thus gliding capacities. Take yourself on a ride knowing that your stand-up-paddle can handle your need for adventures.

All equipped

Enjoy your sport as a free spirit. Your ISup stand-up-paddle is provided with all necessary equipment: ergonomical backpack, double action pump, paddle, foot leash, and repair kit.





MAKO 10'5"



LEVELS

- Beginner
- Intermediate
- Advanced

SPECS

Dimensions	318 x 81 cm / 10'5" x 32"
Thickness	15 cm / 6"
Technology	Drop-Stitch
Max. Charge	115 kg
Fins	1 central slide-in + 2 side fins

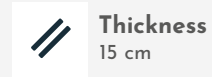

LEISURELY OUTINGS

The MAKO was designed as an all-round stand-up-paddle for long rides on calm waters on a lake or along shores. It has a length of over 3 meters and a width of 81 cm for comfortable rides that quickly pick up in speed.

Its 15 cm thickness enhances this SUP flottability and the Dropstich technology optimizes its rigidity. Enjoy your ride standing for a good view of the horizon or seated in a kayak seat (optional) for a more leisurely outing.

All included Pack

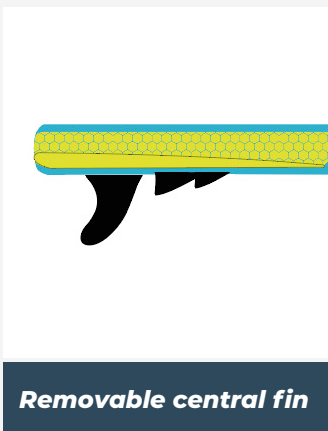
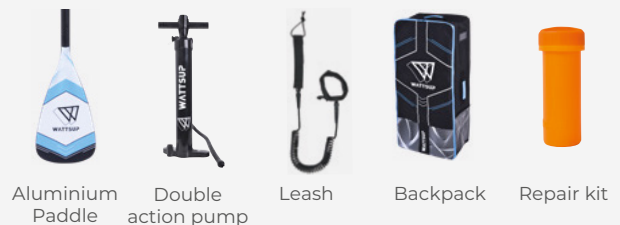

Removable central fin

The "slide in" type fin on all our boards easily slides in and out of its notch with no effect on sturdiness during the ride.

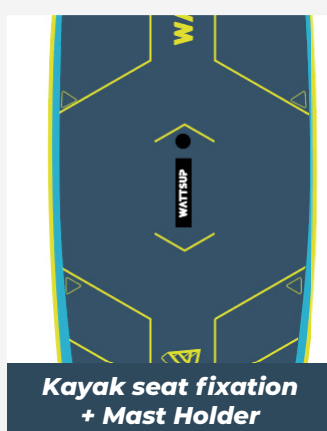

Kayak seat fixation + Mast Holder

The MAKO SUP is equipped with lateral 4 d-rings to install a kayak seat. Standing or seated, the young rider can be comfortably positioned for hours-long outings.

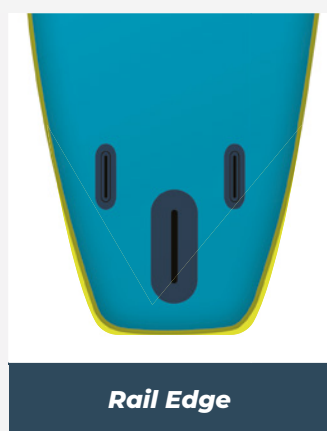

Rail Edge

Thanks to the rail edge, the MAKO sup benefits from a better speed, less friction for a better glide and an increased maneuverability.

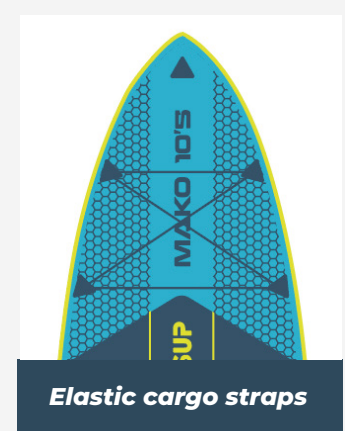

Elastic cargo straps

Stand Up Paddling is a pleasant sport that offers a chance to discover amazing sceneries. Take it further and bring with you supplies that you can secure at the front of your board with the elastic cargo straps.

BREAM 10'6"

RIDE	
SPEED	
WAVE	

LEVELS

Beginner	Intermediate	Advanced
----------	--------------	----------

SPECS

Dimensions	320 x 81 cm / 10'6"x32"
Thickness	15 cm / 6"
Technology	Drop-Stitch
Max. Charge	125 kg
Fins	1 central slide-in + 2 side fins

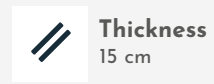

THE SHORES ARE AWAITING

With the BREAM, you will find a well balanced all-round stand-up-paddle. Thanks to its 3.2 meters length, it picks up in speed effortlessly. The Bream will take you out of your shell on discoveries along the most beautiful shores. Invite a friend along. He/She can enjoy a ride sitting on a kayak seat (optional). No need to leave your small equipment behind. Your picnic can be packed in the front cargo straps.

All included Pack // COMBO PACK

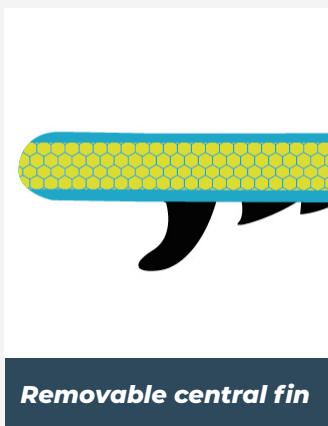

The "slide in" type fin on all our boards easily slides in and out of its notch with no effect on sturdiness during the ride.



The BREAM SUP is equipped with lateral 4 d-rings to install a kayak seat. Standing or seated, the young rider can be comfortably positioned for hours-long outings.

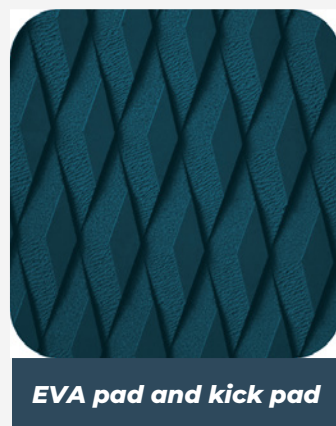

In addition to their modern design, all our boards are equipped with an all-comfort EVA pad and kick pad. The raised surface at the tail of the SUP serves as a support point to easily turn in waves!

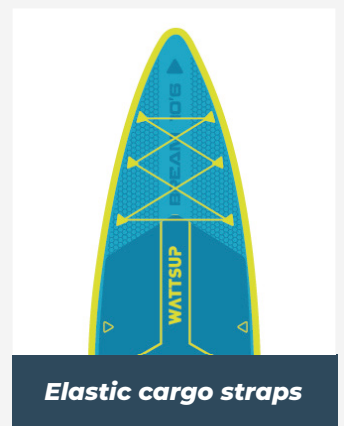

Stand Up Paddling is a pleasant sport that offers a chance to discover amazing sceneries. Take it further and bring with you supplies that you can secure at the front of your board with the elastic cargo straps.



PIKE 11'6''



LEVELS
 Beginner / Intermediate / Advanced

SPECS

Dimensions	350 x 84 cm / 11,6'x33"
Thickness	15 cm / 6"
Technology	Drop-Stitch
Max. Charge	150 kg
Fins	1 central slide-in + 2 side fins



Technology
Dropstich



Thickness
15 cm

A SHARP NOSE FOR FASTER RIDES
 The PIKE SUP was designed with its homonym in mind. Its green turquoise colour and long nose remind of the Pike's colours and shape. A shape also designed to enhance the 3.5 meters length and 84 cm width that make of this stand-up paddle a board that picks up in speed very quickly while offering a stable base to manoeuver it around curves.

All included Pack // COMBO PACK

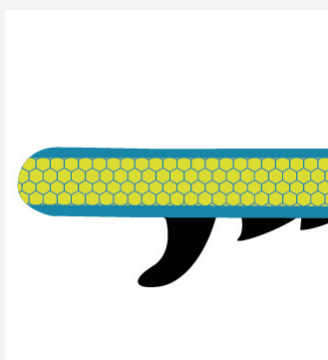
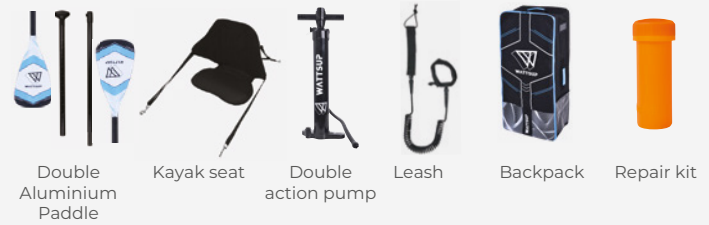

Removable central fin

The "slide in" type fin on all our boards easily slides in and out of its notch with no effect on sturdiness during the ride.



Kayak seat fixation

The PIKE SUP is equipped with lateral 4 d-rings to install a kayak seat. Standing or seated, the young rider can be comfortably positioned for hours-long outings.



EVA pad and kick pad

In addition to their modern design, all our boards are equipped with an all-comfort EVA pad and kick pad. The raised surface at the tail of the SUP serves as a support point to easily turn in waves!



Elastic cargo straps

Stand Up Paddling is a pleasant sport that offers a chance to discover amazing sceneries. Take it further and bring with you supplies that you can secure at the front of your board with the elastic cargo straps.



WHALE 14'6''

RIDE	
SPEED	
WAVE	

LEVELS

Beginner	Intermediate	Advanced
----------	--------------	----------

SPECS

Dimensions	442 x 89 cm / 14,6'x35"
Thickness	15 cm / 6"
Technology	Drop-Stitch
Max. Charge	210 kg
Fins	1 central slide-in



THE LOYALTY OF A TANDEM / BI-PLACE SUP

True to its nature, the WHALE is family SUP that wants every member to enjoy a fun ride on the water. This large board of over 4 meters long and 89 cm wide, can accommodate parents, children and even the family pet.

Everyone can look forward to a day filled with laughter, discovery and adventure. Take along a picnic, binoculars and other small equipment : the Whale comprises elastic cargo straps both at the front and the rear of the board.

All included Pack

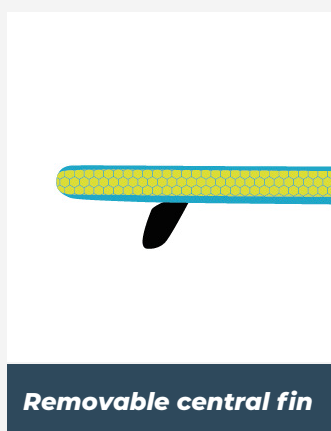
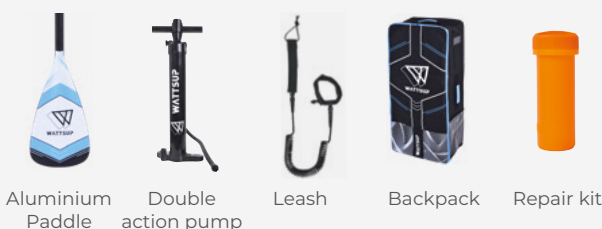

Removable central fin

The "slide in" type fin on all our boards easily slides in and out of its notch with no effect on sturdiness during the ride.

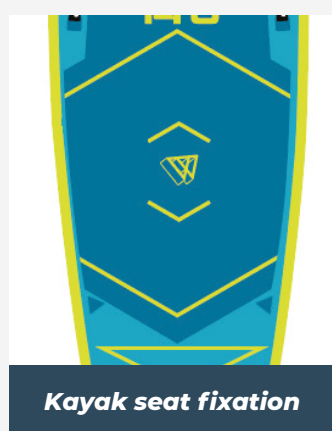

Kayak seat fixation

As a family SUP, the WHALE wants everyone to enjoy a comfortable ride however long the outing is. It is equipped with 8 lateral d-rings to install 2 kayaks seats.

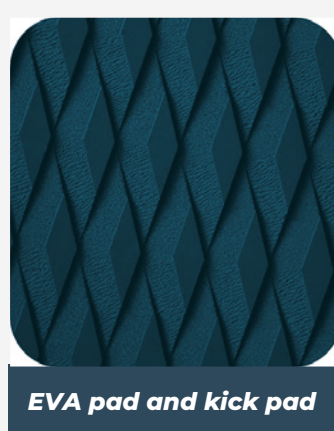

EVA pad and kick pad

In addition to their modern design, all our boards are equipped with an all-comfort EVA pad and kick pad. The raised surface at the tail of the SUP serves as a support point to easily turn in waves!

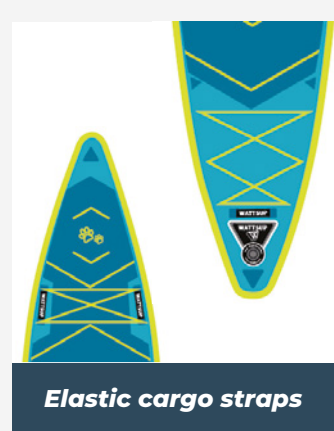

Elastic cargo straps

Stand Up Paddling is a pleasant sport that offers a chance to discover amazing sceneries. Take it further and bring with you supplies that you can secure at the front and the back of your board with the elastic cargo straps.

EXPERIENCES TO BE SHARED



Our technology
**DROP-STITCH
EXTRA-RIGID**

Thousand of polyester strands connect up the top and bottom reinforced PVC layers of the SUP. When inflated at high pressure (15 psi), they tighten up and increase the rigidity of the board; there lays the secret of Drop-Stitch technology.

At WATTSUP, we pay particular attention to the density of the yarn used in its boards. With this new Drop-Stitch confection, inflatable paddleboards are lighter and more rigid.

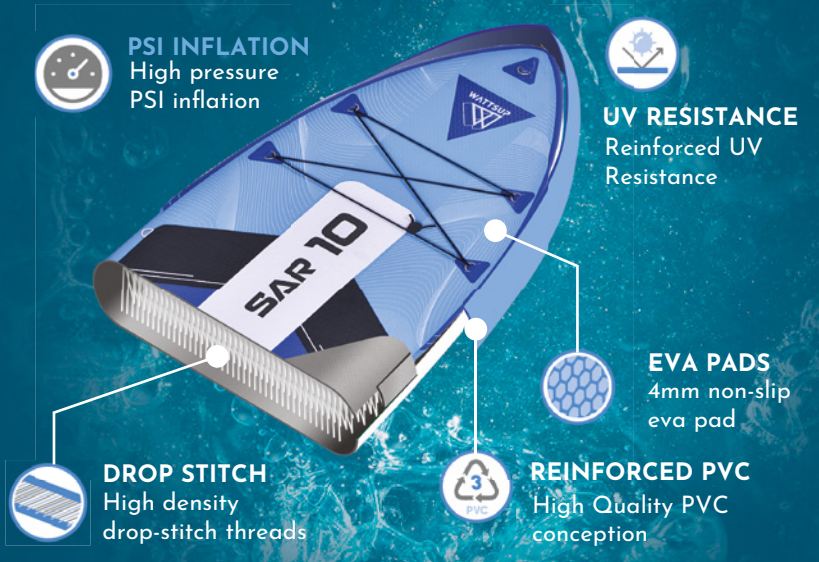

GUPPY 9'

RIDE	
FITNESS	
WAVE	
SPEED	

LEVELS

Beginner	Intermediate	Advanced
----------	--------------	----------

SPECS

Dimensions	275 x 76 cm / 9' x 30"
Thickness	13 cm / 5"
Technology	Drop-Stitch
Max. Charge	80 kg
Fins	1 central slide-in
Ref	PB-WGPY90



- Max. Charge**
80 kg
- Technology**
Dropstich
- Thickness**
13 cm

The GUPPY 9" (275cm) features an all around shape that will guarantee maneuverability and stability for beginners and lighter paddlers. Lighter paddlers up to 80kg - and children can enjoy this new board with a unique 13cm thickness.

Wattsup ends with the 10cm thickness entry level boards to offer a stiffer more durable and more stable iSUP.

All included Pack

- Aluminium Paddle
- Double action pump
- Leash
- Backpack
- Repair kit



Removable central fin

The "slide in" type fin on all our boards easily slides in and out of its notch with no effect on sturdiness during the ride.



Kayak seat fixation

The GUPPY SUP is equipped with lateral 4 d-rings to install a kayak seat. Standing or seated, the young rider can be comfortably positioned for hours-long outings.



EVA pad and kick pad

In addition to their modern design, all our boards are equipped with an all-comfort EVA pad and kick pad. The raised surface at the tail of the SUP serves as a support point to easily turn in waves!



Elastic cargo straps

Stand Up Paddling is a pleasant sport that offers a chance to discover amazing sceneries. Take it further and bring with you supplies that you can secure at the front of your board with the elastic cargo straps.



JELLY 9'6''

RIDE	■ ■ ■ ■ ■
FITNESS	■ ■ ■ ■ ■
WAVE	■ ■ ■ ■ ■
SPEED	■ ■ ■ ■ ■

LEVELS

Beginner / Intermediate / Advanced

SPECS

Dimensions	290 x 76 cm / 9,6' x 30''
Thickness	13 cm / 5''
Technology	Drop-Stitch
Max. Charge	90 kg
Fins	1 central slide-in
Ref	PB-WJLY96

- Max. Charge**
90 kg
- Technology**
Dropstich
- Thickness**
13 cm

With a width of just 30'' (76 cm), the JELLY is the perfect SUP for small or feminine shapes with narrow shoulder span. Practical right through to its accessories, this board comes complete with transport bag, paddle, high pressure pump, foot leash and repair kit. As an entry level board, the Jelly benefits however from the advanced drop-stitch technology, which optimises the board rigidity when inflated, resulting in an exceptional floating and glide quality. From an aesthetic point of view, the JELLY features discreet colours in a set of light grey and purple.

All included Pack

- Aluminium Paddle
- Double action pump
- Leash
- Backpack
- Repair kit



Removable central fin

The "slide in" type fin on all our boards easily slides in and out of its notch with no effect on sturdiness during the ride.



Kayak seat fixation

The Jelly SUP is equipped with lateral 4 d-rings to install a kayak seat. Standing or seated, the young rider can be comfortably positioned for hours-long outings.



EVA pad and kick pad

In addition to their modern design, all our boards are equipped with an all-comfort EVA pad and kick pad. The raised surface at the tail of the SUP serves as a support point to easily turn in waves!



Elastic cargo straps

Stand Up Paddling is a pleasant sport that offers a chance to discover amazing sceneries. Take it further and bring with you supplies that you can secure at the front of your board with the elastic cargo straps.

SAR 10'



RIDE	████████████████████
FITNESS	████████████████████
WAVE	████████████████████
SPEED	████████████████████

LEVELS

Beginner	Intermediate	Advanced
----------	--------------	----------

SPECS

Dimensions	305 x 81 cm / 10' x 32"
Thickness	15 cm / 6"
Technology	Drop-Stitch
Max. Charge	125 kg
Fins	1 central slide-in
Ref	PB-WSAR100

-  **Max. Charge**
125 kg
-  **Technology**
Dropstich
-  **Thickness**
15 cm

Wattsup SAR takes SUP one step further. Longer than its current competitors (10"/305cm), this new all-water board is a new sensation on the iSUP world thanks to its generous volumes.

Wider (32"/81cm) and thicker (6"/15cm), SAR is a versatile board, stiffer and extremely stable.

All included Pack

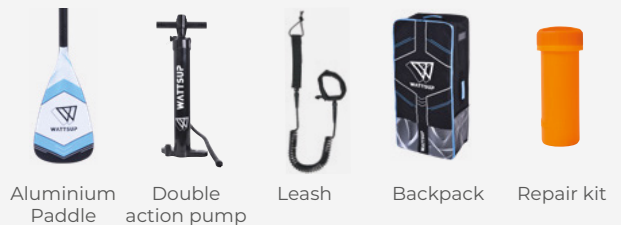

Removable central fin

The "slide in" type fin on all our boards easily slides in and out of its notch with no effect on sturdiness during the ride.



Kayak seat fixation

The Sar SUP is equipped with lateral 4 d-rings to install a kayak seat. Standing or seated, the young rider can be comfortably positioned for hours-long outings.



EVA pad and kick pad

In addition to their modern design, all our boards are equipped with an all-comfort EVA pad and kick pad. The raised surface at the tail of the SUP serves as a support point to easily turn in waves!



Elastic cargo straps

Stand Up Paddling is a pleasant sport that offers a chance to discover amazing sceneries. Take it further and bring with you supplies that you can secure at the front of your board with the elastic cargo straps.



ESPADON 11'

RIDE	██████████
FITNESS	██████████
WAVE	██████████
SPEED	██████████

LEVELS

Beginner	Intermediate	Advanced
----------	--------------	----------

SPECS

Dimensions	335 x 81 cm / 11' x 32"
Thickness	15 cm / 6"
Technology	Drop-Stitch
Max. Charge	145 kg
Fins	1 central slide-in
Ref	PB-WESP111

- Max. Charge**
145 kg
- Technology**
Dropstich
- Thickness**
15 cm

The ESPADON is the perfect board for paddlers looking for an all-in-one board. With its rounded rails and sharper nose, this iSUP gives you great response whether you are touring or wave riding.

Its generous volume offers extra-stiffness to the boards and also ensure enhanced stability for heavy paddlers - up to 145kg!

All included Pack

- Aluminium Paddle
- Double action pump
- Leash
- Backpack
- Repair kit



Removable central fin

The "slide in" type fin on all our boards easily slides in and out of its notch with no effect on sturdiness during the ride.



Kayak seat fixation

The ESPADON SUP is equipped with lateral 4 d-rings to install a kayak seat. Standing or seated, the young rider can be comfortably positioned for hours-long outings.



EVA pad and kick pad

In addition to their modern design, all our boards are equipped with an all-comfort EVA pad and kick pad. The raised surface at the tail of the SUP serves as a support point to easily turn in waves!



Elastic cargo straps

Stand Up Paddling is a pleasant sport that offers a chance to discover amazing sceneries. Take it further and bring with you supplies that you can secure at the front of your board with the elastic cargo straps.



MARLIN 12'

RIDE	██████████
FITNESS	██████████
WAVE	██████████
SPEED	██████████

LEVELS

Beginner	Intermediate	Advanced
----------	--------------	----------

SPECS

Dimensions	365 x 84 cm / 12' x 33"
Thickness	15 cm / 6"
Technology	Drop-Stitch
Max. Charge	160 kg
Fins	1 central slide-in
Ref	PB-WMAR120

- Max. Charge**
160 kg
- Technology**
Dropstich
- Thickness**
15 cm

Extra-volume transforms to MARLIN into a stable water-platform, suitable for heavier riders; up to 160kg.

Its sharp nose and extralength (12"/365cm) provide a unique glide and more speed. 6"/15cm thickness and 33"/84cm width will enhance the stability of the boards to ensure you dry sea trips.

All included Pack

- Aluminium Paddle
- Double action pump
- Leash
- Backpack
- Repair kit



Removable central fin

The "slide in" type fin on all our boards easily slides in and out of its notch with no effect on sturdiness during the ride.



Kayak seat fixation

The MARLIN SUP is equipped with lateral 4 d-rings to install a kayak seat. Standing or seated, the young rider can be comfortably positioned for hours-long outings.

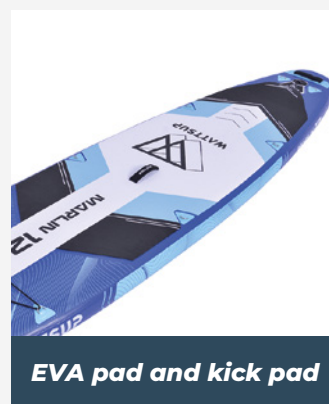

EVA pad and kick pad

In addition to their modern design, all our boards are equipped with an all-comfort EVA pad and kick pad. The raised surface at the tail of the SUP serves as a support point to easily turn in waves!



Elastic cargo straps

Stand Up Paddling is a pleasant sport that offers a chance to discover amazing sceneries. Take it further and bring with you supplies that you can secure at the front of your board with the elastic cargo straps.



SEAL 12'8"

RIDE	██████████
FITNESS	██████████
WAVE	██████████
SPEED	██████████

LEVELS

Beginner	Intermediate	Advanced
----------	--------------	----------

SPECS

Dimensions	388 x 91 cm / 12'8" x 36"
Thickness	15 cm / 6"
Technology	Drop-Stitch
Max. Charge	170 kg
Fins	1 central slide-in
Ref	PB-WSEA128

- Max. Charge**
170 kg
- Technology**
Dropstich
- Thickness**
15 cm

This over-size board at 12'8"x36" can easily carry a rider and a companion, why not a furry friend. Its 6" thickness, just as exceptional for a SUP its category, optimises the board volume and charge capacity to 375 lb (170 kg). These key elements are further enhanced by true advanced double-stitch technology that increases the board rigidity by 40% when inflated, playing an important role in the SEAL floating and gliding capacities.

All included Pack

- Aluminium Paddle
- Double action pump
- Leash
- Backpack
- Repair kit



Removable central fin

The "slide in" type fin on all our boards easily slides in and out of its notch with no effect on sturdiness during the ride.

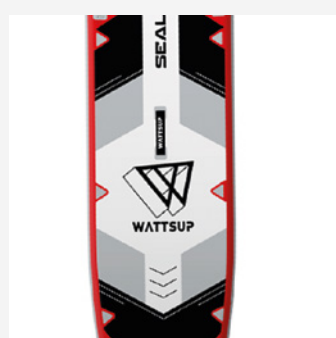

Kayak seat fixation

The SEAL SUP is equipped with lateral 6 d-rings to install 2 kayaks seats. Standing or seated, the young rider can be comfortably positioned for hours-long outings.



EVA pad and kick pad

In addition to their modern design, all our boards are equipped with an all-comfort EVA pad and kick pad. The raised surface at the tail of the SUP serves as a support point to easily turn in waves!



Elastic cargo straps

Stand Up Paddling is a pleasant sport that offers a chance to discover amazing sceneries. Take it further and bring with you supplies that you can secure at the front of your board with the elastic cargo straps.

WINGSUP COLLECTION

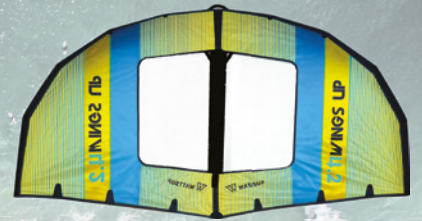

	WINGSUP 3.2	WINGSUP 4.2	WINGSUP 5.2	WINGSUP 6.2
-70 Kg	20 - 40 kn	15 - 35 kn	10 - 30 kn	5 - 15 kn
70 - 90 kg	25 - 45 kn	20 - 40 kn	15 - 35 kn	8 - 18 kn
+90 kg	25 - 50 kn	20 - 45 kn	18 - 40 kn	10 - 20 kn

ABOUT THE WINGSUP COLLECTION

With just a light breeze, discover new sensations with the Wings Up. Follow your mood of the moment, pack up your paddle in the holder provided and turn your stand-up-paddle into a wind ride.

With the Wings Up, WattSup demonstrates again its ability to remain ahead of market demand. An easy-use wing suited to any standard stand-up-paddle or foil.

Everything on the Wings Up has been thought to make rider's experience safe and easy: multiple reinforcements, ergonomic handles, and rapid inflation system.

Included in pack

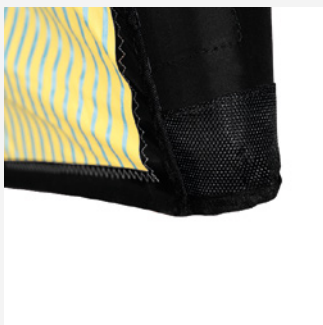

Kevlar reinforcement

On all areas likely to be damaged during use, WattSup adds a number of kevlar reinforcements to practice your sport without any risk of deterioration to the equipment.



Paddle holder

The Wings Up has a paddle holder to quickly switch from a paddle practice to the Wingsup practice. This system allows you to position your hands on the long handle of the paddle while using the wing (paddle not included).



Ergonomic handles

Ergonomical and reinforced, the handles on the Wings Up have a beautiful finish. The front handle moderates the pressure on the rider's arms and diagonal handles have been added for easy technical manoeuvres.



Rapid inflation system

The wing has a quick inflation system, ideal to enhance rider's experience. Another smart option ensures the wing's air pressure is distributed according to user's preferences.

ACCESSORIES

CARBON PURE

Dimensions	From 165 to 215cm
Technology	100% Carbon
Number of sections	3 sections
Weight	< 630gr
Shaft	100% Carbon
Blade	100% Carbon
Float	Yes
Adjustable	Yes

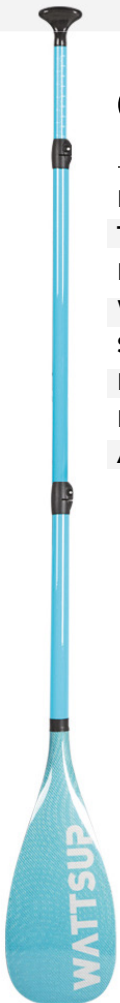

CARBON AIR

Dimensions	From 170 to 215cm
Technology	30% carbon 70% FG
Number of sections	3 sections
Weight	650 - 700 gr
Shaft	30% carbon 70% FG
Blade	Fiber glass
Float	Yes
Adjustable	Yes



CARBON LITE

Dimensions	From 170 to 215cm
Technology	Fiber glass + carbon layer
Number of sections	3 sections
Weight	750 - 800 gr
Shaft	FG + carbon layer
Blade	Fiber glass
Float	Yes
Adjustable	Yes



LEASH

Dimensions	10' // 3m étiré
Cable	8mm
Leash	Coiled



DECKBAG

Capacity	22L
Loading bungee	Yes
Material	TPU

- Waterproof



PRESSURE SOLAR SHOWER

Capacity	11L
Dimensions	40x20cm
Hose length	200cm
Tank material	PVC
Shower head material	ABS
Weight	800g







Collection iSUP

Collection Kayak



Collection Sup Rigide

Surf Range



ABOUT COASTO

HIGH-END INFLATABLE SUPS

The Stand-Up-paddles by Coasto are the result of countless hours of consultation with professional riders, engineers and technicians to create the perfect inflatable board for the experienced rider. The TTS (Thermo Twin Skin) is a reflection of this effort: a technology that comprises two PVC layers thermally bonded and supported by a drop-stitch concept to optimize compactness and therefore rigidity and lightness.

The manoeuvrability of the Coasto SUPs is assured by the shape of the boards and their increased nose rocker. With board lengths ranging from 7'5" to 14", Coasto is a brand that will accompany the young beginner on his/her path to professional riding and the thrill of speed gliding on waters.

SOLUTIONS AT THE FOREFRONT OF PROGRESS

Coasto is constantly evolving to remain at the forefront of progress and brings carefully studied solutions for the comfort of the rider. To meet today's market demand, every Coasto Stand-Up-Paddle is available either as a single chamber or double chamber solution.



@loliloc2c



@van_cationfiedlers



@supnbxl



@support_budapart



@beti_faktografia



@by__mich

ISUP COASTO TECHNOLOGY

Making high performance in aquatic sport accessible to all is at the heart of Coasto's mission.

Close collaborations between experts in their field - engineers, technicians, top athletes and, above all, board sports enthusiasts - have produced ingenious ideas.

A set of finely designed components for equipment and accessories that accompany riders through their wildest adventures.



DUAL CHAMBER

DOUBLE CHAMBER PUTTING RIDERS' SAFETY FIRST

Whilst most boards are made up of just one air chamber, those benefiting of the Double Chamber technology count two separate air chambers giving them exceptional capacities:

SINGLE CHAMBER



DUAL CHAMBER



RIGIDITY

Gain in rigidity by 30% : with the second integrated chamber and its side panels, the rider enjoys a ride of the same quality as with a rigid board.

SAFETY

Rider's safety: should the outside chamber encounter a leak, the separate inside chamber insures the SUP buoyancy.

STABILITY

Double Chamber stand-up-paddle gain in stability



Thermo Twin Skin
glueless technology



**ROBUST AND
STABILITY**



COMFORT EVA

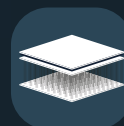

**DROPSTITCH
DOUBLE LAYER**

TTS THERMO TWIN SKIN

Boards built with two PVC layers are much stiffer and more durable than single layer entry-line boards. They however produce a heavier board on which some esthetical imperfections might occur. This is how **Thermo Twin Skin TTS® Technology** was born. A revolution in the stand-up-paddle market. A unique technology consisting of thermal fusion. The two layers of PVC are no longer bonded. They are now thermo-welded, meaning that heat is used instead of glue.

TTS TECHNOLOGY COMES WITH CONSIDERABLE ADVANTAGES:

LIGHTER

An important quantity of heavy glue is needed to cover the surface of a paddle board. By removing the glue, boards are 20 to 25% lighter!

HIGH END LOOK

Gluing the two layers can cause some visual imperfections, such as bubbles, pleats or blemishes, when glue is not well spread. Boards built with TTS® are smoother and have perfect finishes.

MORE DURABLE

In the long run, these same imperfections can lead to peeling. Avoiding glue offers a more qualitative board for many years.

STIFFER

Welding the two PVC layers at the early stage of the conception offers a super-stiff surface for greater floatability and rigidity.



ISUP *COASTO*



HOOK 7'5''

DIMENSIONS 226x66cm 7'5" x 26"	THICKNESS 10cm / 4"	VOLUME 185L
MAX CHARGE 70 kg	TECHNOLOGY Drop Stitch TTS	MAX. AIR PRESSURE 15 psi

LEVELS

	BEGINNER	INTERMEDIATE	ADVANCED
RIDE	████████	████████	████████
FITNESS	████████	████████	████████
WAVE	████████	████████	████████
SPEED	████████	████████	████████

MAX. CHARGE 70 kg
 TECHNOLOGY Dropstich TTS
 THICKNESS 10 cm

AN EXTREMELY FUN STAND-UP PADDLE FOR KIDS!
 The new HOOK paddle is a model configured to be sturdy to ensure safe learning. Coasto's TTS technology reduces the weight of the paddle by 30%, which makes it much easier to transport!
 Equipped with a removable fin, the HOOK is a versatile stand-up paddle that is very easy to handle and is recommended for learning.

ALL INCLUDED PACKAGE COASTO

Padded Back pack with wheels	Double action pump	Anodised Aluminium Paddle	Leash

ALL AROUND SHAPE

HOOK 7'5'' IN DETAILS

CAMERA MOUNT

To film paddle scenes during the sessions, the SUP Hook has a front end to attach a waterproof camera such as GoPro.

2 IN 1 CENTRAL HANDLE

The ergonomic and soft central handle allows you to carry the paddle without difficulty and to attach a paddle or a bottle.

CARGO STRAPS

To always have your belongings at hand in a waterproof bag, the model has an adjustable front and back cargo straps.

REMOVABLE FIN

To save space when storing the paddle, the HOOK model is equipped with a removable fin that can be attached without the use of tools.



AMERIGO 10'4''

DIMENSIONS 315x84 cm 10'4" x 33"	THICKNESS 15cm / 6"	VOLUME 290L
MAX CHARGE 125 kg	TECHNOLOGY Drop Stitch TTS	MAX. AIR PRESSURE 15 psi

LEVELS

	BEGINNER	INTERMEDIATE	ADVANCED
RIDE	██████████	██████████	██████████
FITNESS	██████████	██████████	██████████
WAVE	██████████	██████████	██████████
SPEED	██████████	██████████	██████████

- MAX. CHARGE**
125 kg
- TECHNOLOGY**
Dropstich TTS
- THICKNESS**
15 cm

A STABLE AND EASY TO HANDLE PADDLE BOARD

The SUP AMERIGO is a new generation board developed for allround paddling. The Thermo Twin Skin technology allows the new Coasto SUP to reduce its weight by 30% and gives it increased rigidity to gain in maneuverability and is clearly more robust.

With a bumper and 3 fins, the AMERIGO 10'4'' is a paddle that is easy to keep on course in any situation. The Eva pad developed by Coasto is thick and grippy to protect the foot joints during long distance paddling.

ALL INCLUDED

PACKAGE COASTO

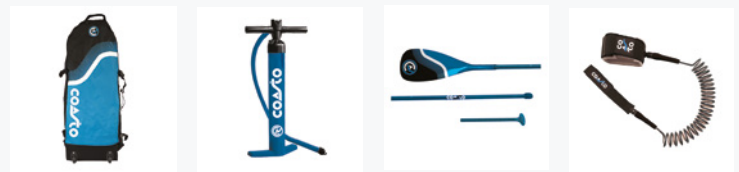

Padded Back pack with wheels

Double action pump

Anodised Aluminium Paddle

Leash

ALL AROUND SHAPE

AMERIGO 10'4'' IN DETAILS

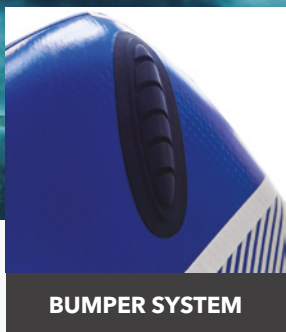

BUMPER SYSTEM

Its pointed shape combined with the Bumper system improves the paddle's sailing quality by breaking waves on its trajectory. The Bumper also extends the life of the paddle.



CAMERA MOUNT

To immortalize every moment spent during surfing sessions, the SUP Amerigo has a front end to attach a waterproof camera such as Gopro



2 IN 1 CENTRAL HANDLE

The ergonomic and soft central handle allows you to carry the paddle without difficulty and to attach a paddle or a bottle.



ERGONOMIC EVA

The thickness of the Eva mat was chosen by Coasto to increase the comfort of the rider's feet and thus eliminate arch pain during long rides.

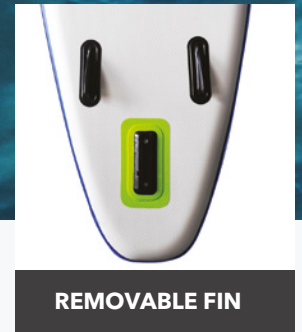

REMOVABLE FIN

The AMERIGO paddle has 3 fins for seamless course maintenance to limit fatigue caused by drift during acceleration and direction changes.



ARGO 11'

DIMENSIONS 335x84 cm 11' x 33''	THICKNESS 15cm / 6''	VOLUME 315L
MAX CHARGE 140 kg	TECHNOLOGY Drop Stitch TTS	MAX. AIR PRESSURE 15 psi

LEVELS

	BEGINNER	INTERMEDIATE	ADVANCED
RIDE	████████	████████	████████
FITNESS	████████	████████	████████
WAVE	████████	████████	████████
SPEED	████████	████████	████████

- MAX. CHARGE**
140 kg
- TECHNOLOGY**
Dropstich TTS
- THICKNESS**
15 cm

A TOURING BOARD WITH MANY ADVANTAGES

Fast, stable and maneuverable are without a doubt the main assets of the new Coasto ARGO 11" inflatable board.

Its thick, grippy pad combined with the board's volume (335x84x15 cm) allow the user to be extremely stable in the most extreme situations. To keep the board on course and obtain a perfect glide, the paddle is equipped with 3 fins and a bumper at the front of the board, on the lower part to break the chop.

ALL INCLUDED

PACKAGE COASTO

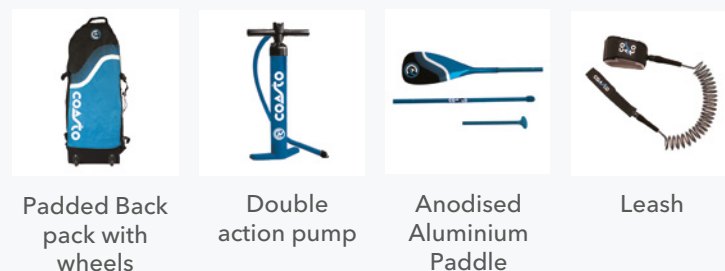

Padded Back pack with wheels

Double action pump

Anodised Aluminium Paddle

Leash

TOURING SHAPE

ARGO 11' IN DETAILS

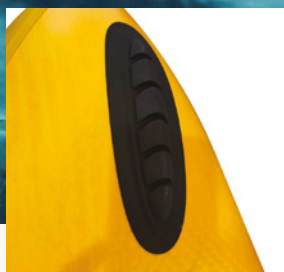

BUMPER SYSTEM

Its pointed shape combined with the Bumper system improves the paddle's gliding quality by breaking waves on its cruising trajectory. The Bumper also extends the life of the paddle.



CAMERA MOUNT

The new D-ring located at the front of the paddle has a mounting system for a Gopro camera to immortalize your paddling adventure.



2 IN 1 CENTRAL HANDLE

The ergonomic and soft central handle allows you to carry the paddle without difficulty and to attach a paddle or a bottle.

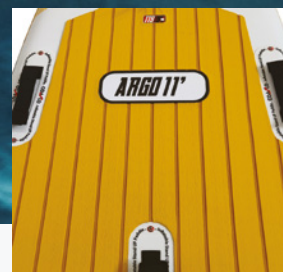

ERGONOMIC EVA

The thickness of the Eva mat was chosen by Coasto to increase the comfort of the rider's feet and thus eliminate arch pain during long rides.

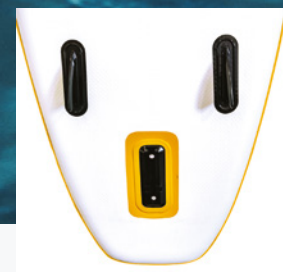

REMOVABLE FIN

With great maneuverability, the board has 3 fins to maintain a smooth course to limit fatigue and drift during acceleration and direction changes.



NAUTILUS 11'8''

DIMENSIONS 355x86 cm 11'8" x 34"	THICKNESS 15cm / 6"	VOLUME 350L
MAX CHARGE 160 kg	TECHNOLOGY Drop Stitch TTS	MAX. AIR PRESSURE 15 psi

LEVELS

	BEGINNER	INTERMEDIATE	ADVANCED
RIDE	██████████	██████████	██████████
FITNESS	██████████	██████████	██████████
WAVE	██████████	██████████	██████████
SPEED	██████████	██████████	██████████

- MAX. CHARGE**
160 kg
- TECHNOLOGY**
Dropstich TTS
- THICKNESS**
15 cm

A STABLE AND FAST TOURING BOARD

The NAUTILUS is a new generation board developed for touring in optimal conditions.

The Thermo Twin Skin technology allows the new Coasto SUP to reduce its weight by 30% and gives it increased rigidity which allows it to gain in maneuverability.

With a thick, grippy pad for long distances, the brand opts to add 3 fins to obtain a foolproof course maintenance and limit fatigue during acceleration.

ALL INCLUDED

PACKAGE COASTO

- Padded Back pack with wheels
- Double action pump
- Anodised Aluminium Paddle
- Leash

TOURING SHAPE

NAUTILUS 11'8'' IN DETAILS



BUMPER SYSTEM

Its pointed shape combined with the Bumper system improves the paddle's sailing quality by breaking waves on its trajectory. The Bumper also extends the life of the paddle.



CAMERA MOUNT

The new D-ring located at the front of the paddle has a mounting system for a Gopro camera to immortalize your paddling adventure.



2 IN 1 CENTRAL HANDLE

The ergonomic and soft central handle allows you to carry the paddle without difficulty and to attach a paddle or a bottle.

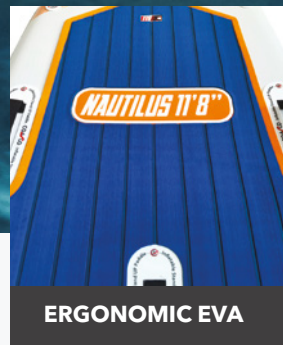

ERGONOMIC EVA

The thickness of the Eva pad was chosen by Coasto to increase the comfort of the rider's feet and thus eliminate arch pain during long rides.

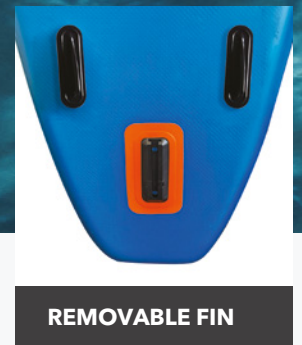

REMOVABLE FIN

The NAUTILUS has 3 fins for seamless course keeping to limit fatigue caused by drift during acceleration and direction changes.



CRUISER 13'1''

DIMENSIONS 398x79 cm 13'1" x 31"	THICKNESS 15cm / 6"	VOLUME 370L
MAX CHARGE 180 kg	TECHNOLOGY Drop Stitch TTS	MAX. AIR PRESSURE 15 psi

LEVELS

	BEGINNER	INTERMEDIATE	ADVANCED
RIDE	████████	████████	████████
FITNESS	████████	████████	████████
WAVE	████████	████████	████████
SPEED	████████	████████	████████

MAX. CHARGE 180 kg
 TECHNOLOGY Dropstich TTS
 THICKNESS 15 cm

TAKE ON THE WAVES

The CRUISER's almost 4 meters length calls for high speed and great manoeuvring. The TTS technology on this stand-up-paddle grants it incredible lightness. Choose the Double Chamber model and take your rider over the shore lines.

Picking up speed at the first stroke of the paddle, this board will take its rider on exhilarating glides in waves. The EVA central and kick pad ensure feet are steady and do not slip.

ALL INCLUDED

PACKAGE COASTO

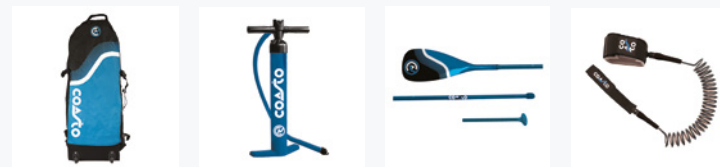

Padded Back pack with wheels

Double action pump

Anodised Aluminium Paddle

Leash

TOURING SHAPE

CRUISER 13'1'' IN DETAILS



BUMPER SYSTEM

Its pointed shape combined with the Bumper system improves the paddle's sailing quality by breaking waves on its trajectory. The Bumper also extends the life of the paddle.



CAMERA MOUNT

The new D-ring located at the front of the paddle has a mounting system for a Gopro camera to immortalize your paddling adventure.



2 IN 1 CENTRAL HANDLE

The ergonomic and soft central handle allows you to carry the paddle without difficulty and to attach a paddle or a bottle.



ERGONOMIC EVA

The thickness of the Eva pad was chosen by Coasto to increase the comfort of the rider's feet and thus eliminate arch pain during long rides.



REMOVABLE FIN

With great maneuverability, the board has 3 fins to maintain a smooth course to limit fatigue and drift during acceleration and direction changes.



TURBO 12'6''

DIMENSIONS 381x76 cm 12'6" x 30"	THICKNESS 15cm / 6"	VOLUME 320L
MAX CHARGE 170 kg	TECHNOLOGY Drop Stitch TTS	MAX. AIR PRESSURE 15 psi

LEVELS

	BEGINNER	INTERMEDIATE	ADVANCED
RIDE	██████████	██████████	██████████
FITNESS	██████████	██████████	██████████
WAVE	██████████	██████████	██████████
SPEED	██████████	██████████	██████████

MAX. CHARGE 170 kg
 TECHNOLOGY Dropstich TTS
 THICKNESS 15 cm

STABILITY FOR THRILLING EXPERIENCES

The Turbo is a unique stable and fast stand-up-paddle. It offers an ultra-stable board while keeping fast-tracking and unforgettable glide experience for riders. This extra-volume board is also super-stiff, light and durable thanks to the TTS® Technology. Advanced cruise lovers, beginners and thrill seekers will all be surprised by the Turbo's performance capacities.

All Coasto stand-up-paddles are provided complete with an ergonomical backpack, a high pressure double action pump, a paddle and a foot leash.

ALL INCLUDED

PACKAGE COASTO

Padded Back pack with wheels	Double action pump	Anodised Aluminium Paddle	Leash

RACE SHAPE

TURBO 12'6'' IN DETAILS



BUMPER SYSTEM

Its pointed shape combined with the Bumper system improves the paddle's sailing quality by breaking waves on its trajectory. The Bumper also extends the life of the paddle.



CAMERA MOUNT

The new D-ring located at the front of the paddle has a mounting system for a Gopro camera to immortalize your paddling adventure.



2 IN 1 CENTRAL HANDLE

The ergonomic and soft central handle allows you to carry the paddle without difficulty and to attach a paddle or a bottle.

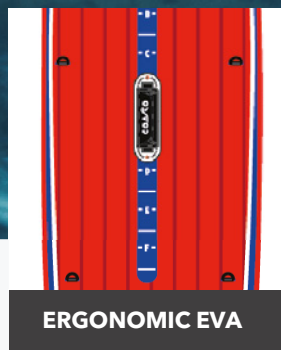

ERGONOMIC EVA

The thickness of the Eva mat was chosen by Coasto to increase the comfort of the rider's feet and thus eliminate arch pain during long rides.

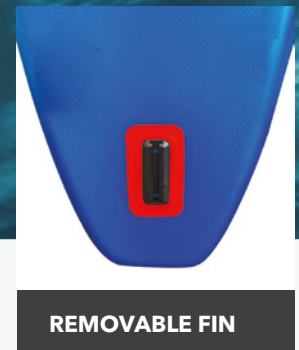

REMOVABLE FIN

The TURBO has 1 fin for seamless course keeping to limit fatigue caused by drift during acceleration and direction changes.



SUPER TURBO 14'

DIMENSIONS 427x71 cm 14' x 28"	THICKNESS 15cm / 6"	VOLUME 315L
MAX CHARGE 180 kg	TECHNOLOGY Drop Stitch TTS	MAX. AIR PRESSURE 15 psi

LEVELS

	BEGINNER	INTERMEDIATE	ADVANCED
RIDE	██████████	██████████	██████████
FITNESS	██████████	██████████	██████████
WAVE	██████████	██████████	██████████
SPEED	██████████	██████████	██████████

 MAX. CHARGE 180 kg	 TECHNOLOGY Dropstich TTS	 THICKNESS 15 cm
--	--	---

THE RACING SUP

Fast and innovative, the SUPER TURBO is tailor-made for competition. Designed with the ultimate Race specifications - 14'x28"x6" - the SUPER TURBO is offering more for true champions. TTS Technology is combined with smart and valuable extra-features such as EVA central and kick pad for outstanding comfort and grip.

Choose the Double Chamber model and take your racing spirit always further. Bring along your action camera and capture your most incredible moments.

ALL INCLUDED

PACKAGE COASTO

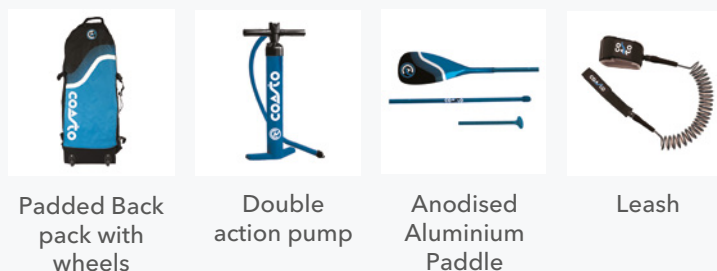

Padded Back pack with wheels

Double action pump

Anodised Aluminium Paddle

Leash

RACE SHAPE

SUPER TURBO 14' IN DETAILS



BUMPER SYSTEM

Its pointed shape combined with the Bumper system improves the paddle's gliding quality by breaking waves on its cruising trajectory. The Bumper also extends the life of the paddle.



CAMERA MOUNT

The new D-ring located at the front of the paddle has a mounting system for a GoPro or Kodak camera to immortalize your paddling adventure.



2 IN 1 CENTRAL HANDLE

The ergonomic and soft central handle allows you to carry the paddle without difficulty and to attach a paddle or a bottle.

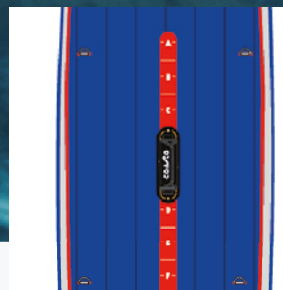

ERGONOMIC EVA

The thickness of the Eva mat was chosen by Coasto to increase the comfort of the rider's feet and thus eliminate arch pain during long rides.



REMOVABLE FIN

With great maneuverability, the board has 1 fin to maintain a smooth course to limit fatigue and drift during acceleration and direction changes.

WING COASTO



ABOUT THE WINGSUP COLLECTION

The Coasto Wing fly has been thought to make your experience an easy and memorable one. With its shape, you will easily pick up speed while riding. The wing offers easy control and comfort thanks to its ergonomical handles.

Everything on the Wing Fly has been thought to make rider's experience safe and easy

High quality fabric has been used with an extension by the top edge to avoid any risk of tearing.

KEY POINTS OF WINGSUP COLLECTION



Valve

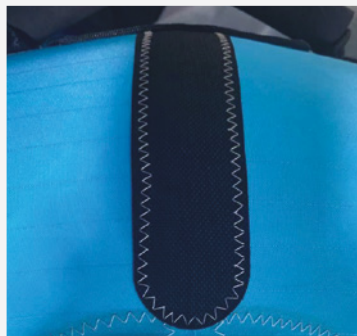

Reinforcement Patch



Handles



Bladder lock

PACK WING + BOARD

WING 5.1



Dimensions	5'1"
SPI	IYU4068 Double Ripstop
Leading edge	Dacron
Bladder	TPU 0,1mm
One pump system	Yes
Leash attachment	Yes
Handles	x3 Neoprene
Wind range	10-25 knots
Weight	2,8kg

WINGBOARD 8'6"



DIMENSIONS 8'6"x33"	THICKNESS 13cm / 5"	Footstrap 2x amovible
MAX CHARGE 90kg	TECHNOLOGY Drop Stitch TTS	MAX. AIR PRESSURE 15 psi

LEVELS

BEGINNER	INTERMEDIATE	ADVANCED
----------	--------------	----------

WING				
WIND SUP				
WAVE				
SPEED				

MAX LOAD
90 kg

TECHNOLOGY
Dropstich TTS

THICKNESS
13 cm

MAST HOLDER

COLLECTION

INFLATABLE KAYAK



<i>LOTUS</i>	<i>1P</i>	<i>2P</i>
Dimensions	310x85cm	410x85cm
Construction	PVC Tubes + dropsitch	PVC Tubes + dropsitch
Max. Weight	120 kg	170 kg
Capacity	1 Person	2 Persons
Technology	Dropstitch	Dropstitch
Usages	Cruising / Initiation / Touring	

 **MAX. CHARGE**
120 to 170 kg

 **TECHNOLOGY**
Dropstitch

 **CAPACITY**
1P // 2P

ALL INCLUDED

PACKAGE COASTO



Back Pack



Kayak seat



4pcs Paddle



HP Pump

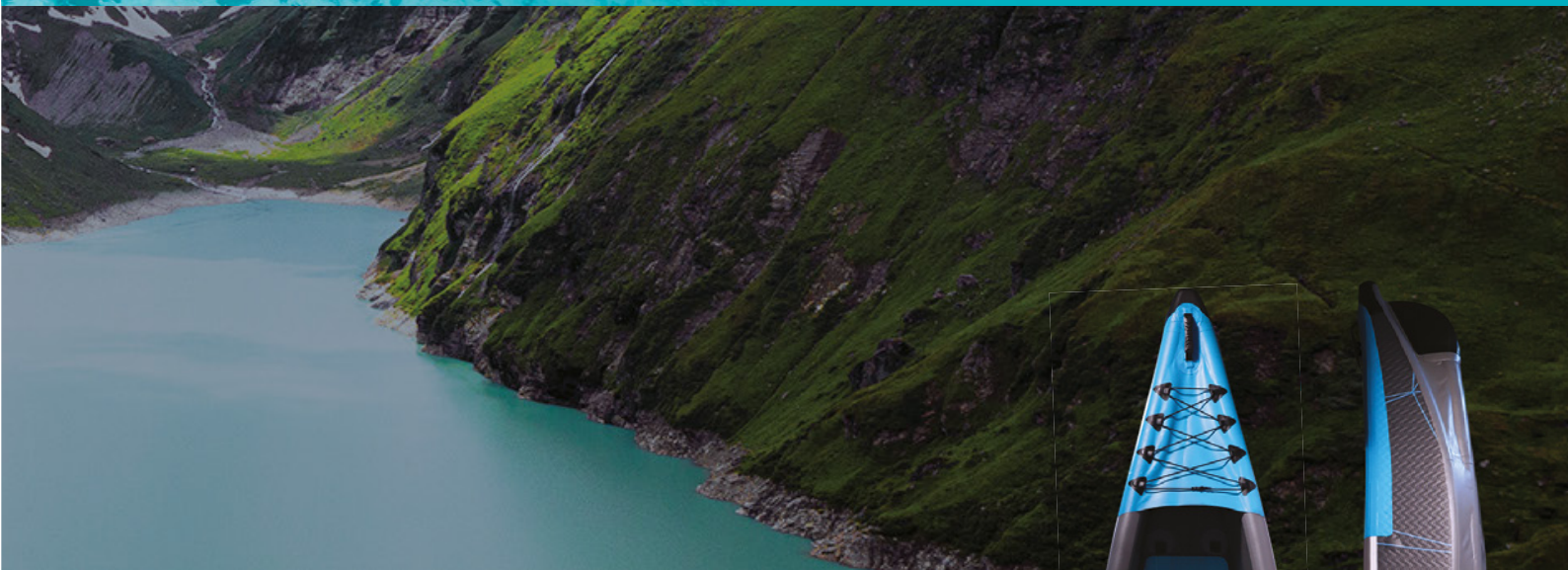

RUSSEL

1P

2P

3P

Dimensions	360x75cm	430x80cm	480x90cm
Construction	Dropstitch	Dropstitch	Dropstitch
Max. Weight	130 kg	200 kg	260 kg
Capacity	1 Person	2 Persons	3 Persons
Technology	Full Dropstitch	Full Dropstitch	Full Dropstitch
Usages	Initiation / Touring		

 **MAX. CHARGE**
130 to 260 kg

 **TECHNOLOGY**
Full Dropstitch

 **CAPACITY**
1P to 3P

ALL INCLUDED

PACKAGE COASTO



Back Pack



Kayak seat



4pcs Paddle



HP Pump

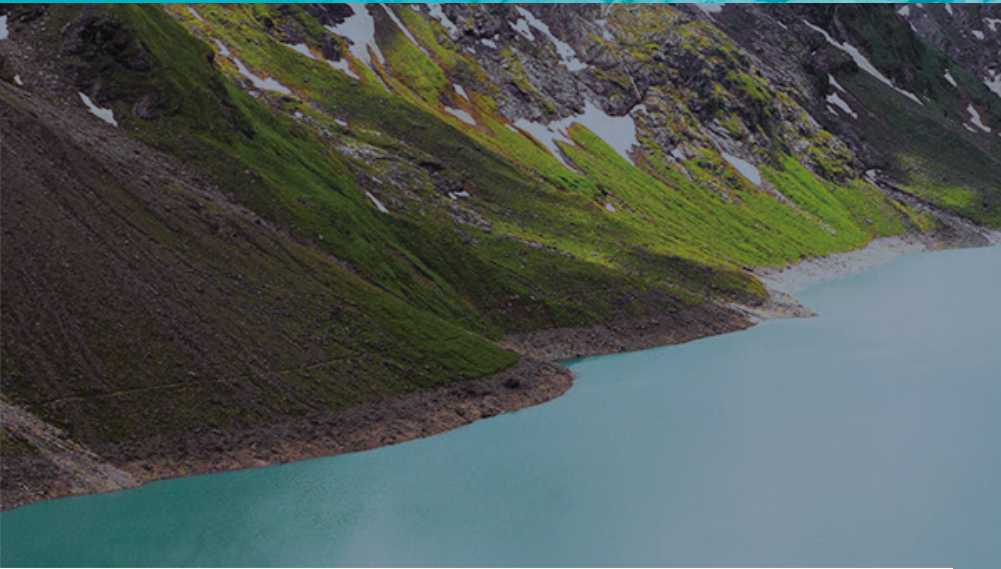

CAPITOLE

1P

2P

Dimensions	385x80cm	426x90cm
Construction	PVC Reinforced	PVC Reinforced
Max. Weight	140 kg	250 kg
Capacity	1 Person	2 Persons
Technology	Dropstitch	Dropstitch
Usages	Initiation / Touring	

KAYAK

CAPITOLE 1P // 2P IN DETAILS

INFLATED TO 12 PSI

Coasto opts for the high density drop-stitch technology and 2 air chambers inflated to 12 PSI so that the Capitole gets a great rigidity and reproduces the feeling of a rigid kayak without its constraints.

THE HANDLES

The reinforced fabric handles are positioned to carry the model once inflated with great ease.

CARGO STRAPS

Indispensable for long journeys, the Capitole has a cargo straps system on the front and rear to hold waterproof bags.

OPTIMIZE FOR WAVES

The thin and rigid bow of the kayak allows to split the waves and drastically improve the speed. This offers a better glide and reduces the effort.

PERFORMANCE AND SAFETY

To ensure that the kayaker uses the model safely, the kayak is made of reinforced PVC which gives it increased resistance to perforation.

ALL INCLUDED

PACKAGE COASTO

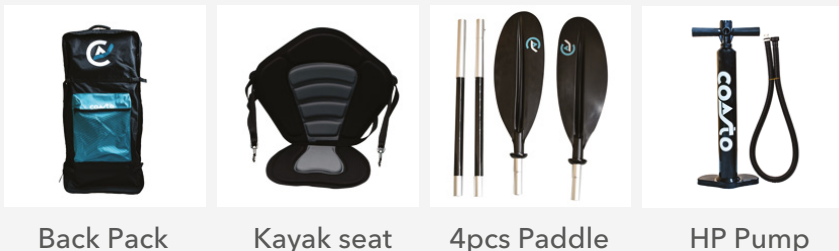

Back Pack

Kayak seat

4pcs Paddle

HP Pump

ZINI SUP KAYAK

SPECS

Dimensions	340x90cm
Max. Weight	200 kg
Capacity	1p
Technology	Full Dropstitch
Usages	Initiation / Touring



MAX. CHARGE
200 kg



TECHNOLOGY
Full Dropstitch



CAPACITY
1P

ALL INCLUDED

PACKAGE COASTO



Backpack with wheels



Kayak seat



4pcs Paddle



HP Pump



Skirt



Leash

DROPSTITCH KAYAK SEAT

Technology	Dropstitch
------------	------------

7 cm Dropstitch seat and neoprene back



COLLECTIONS

SUP RIGIDES



HARMONY 10'8''

DIMENSIONS 325x81 cm 10'8" x 32"	THICKNESS 13cm / 5"	VOLUME 210L
MAX CHARGE 130 kg	TECHNOLOGY Epoxy + Bamboo	

LEVELS

BEGINNER	INTERMEDIATE	ADVANCED
-----------------	---------------------	-----------------

RIDE				
FITNESS				
WAVE				
SPEED				

MAX. CHARGE
130 kg

TECHNOLOGY
EPOXY + Bamboo



ALLURE 11'

DIMENSIONS 335x78 cm 11' x 31"	THICKNESS 13cm / 5"	VOLUME 280L
MAX CHARGE 140 kg	TECHNOLOGY Epoxy + Soft EVA	

LEVELS

BEGINNER	INTERMEDIATE	ADVANCED
-----------------	---------------------	-----------------

RIDE				
FITNESS				
WAVE				
SPEED				

MAX. CHARGE
140 kg

TECHNOLOGY
Epoxy + Soft EVA

MAJESTIC 14'

DIMENSIONS 426x62 cm 14' x 24,5"	THICKNESS 21cm / 8,4"	VOLUME 290L
MAX CHARGE 110 kg	TECHNOLOGY Epoxy + Carbon	

LEVELS

BEGINNER	INTERMEDIATE	ADVANCED
----------	--------------	----------

RIDE	██████████	██████████	██████████	██████████
FITNESS	██████████	██████████	██████████	██████████
WAVE	██████████	██████████	██████████	██████████
SPEED	██████████	██████████	██████████	██████████

 **MAX. CHARGE**
110 kg

 **TECHNOLOGY**
Epoxy + Carbon



ABOUT THE RANGE

HARMONY 10'8" / ALLURE 11' / MAJESTIC 14'

Coasto puts the spotlight on its range of rigid stand-up-paddles. A reflection of in-depth studies that have produced boards with an astonishingly gliding capacity. EPS foam enveloped in several fiberglass layers, reinforced with 2 wooden stringers. This conception affords an optimum sturdiness-lightness combination. All of Coasto's hard boards are equipped with the necessary deck vent guaranteeing the stand-up-paddle's durability over time through temperature changes.

Whether you are riding the waves or enjoying traditional stand-up-paddle outings on calm waters, you can do it with peace of mind, knowing that your Coasto equipment is made of high quality material. 4 d-rings have been placed where a kayak seat (optional) can be attached, and cargo straps are provided to secure light material during the ride.

COLLECTION AIRSURF



AIR SURF 6'

AIR SURF 8'

Dimensions	180x51 cm // 5'9"x20"	244x57 cm // 8'x22"
Thickness	8 cm // 3"	8 cm // 3"
Max. Weight	80 kg	80 kg
Technology	Double layer fusion Dropstitch	Double layer fusion Dropstich
Volume	54 L	81 L
Config. Aileron	3x Single fin	3x Single fin

Levels

BEGINNER

INTERMEDIATE

ADVANCED

ALL INCLUDED

PACKAGE COASTO



TRANSPORT BAG COASTO



HP PUMP DOUBLE ACTION



LEASH COILED 8"

SOFT SURF



5'10"

6'

7'

8'

9'

Lenght

5'10"

6'

7'

8'

9'

Type

Fish

Shortboard

Evolute

Malibu

Longboard

Core

EPS

EPS

EPS

EPS

EPS

Stringer

x2 Wood

x2 Wood

x2 Wood

x2 Wood

x2 Wood

ABOUT THE RANGE

SOFT SURF

STURDY SOFT BOARDS TO IMPROVE YOUR SURFING SKILLS

In line with its mission to remain at the forefront of market demand, Coasto introduces a range of soft top surfboards. A concept finely elaborated by its Research & Development team to produce soft surfing boards that are practical for any person wishing to discover the thrills of surfing.

The new surfer can safely work out his/her new skills on a board that provides perfect rigidity, stability, and manoeuvrability. Coasto's soft surfboards are made out of a soft foam material covering a sturdy EPS high-density foam stringer. A thruster, or third fin, equips every model for easier wave surfing.

TOWABLE TUBE



ADVANCED TECHNOLOGY IN FUN WATER ACTIVITIES

The range includes 7 different models. A round shape, true reminder of the traditional tube that can accommodate 1 2 3 persons, an ergonomical shape with side wings and several strategically placed handles, and a tube shape for up to 3 people riding in a tandem.

With its towable tubes range, Coasto puts its cutting-edge technologies at the service of the water leisure market.

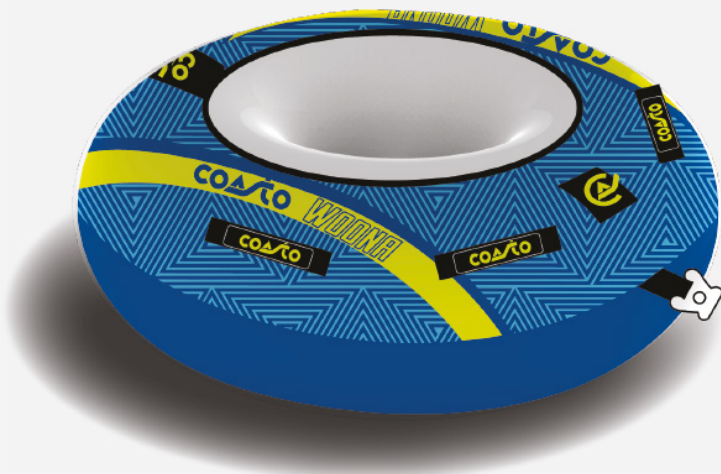

WOODNA

MARDA

Dimensions	137cm // 54"	152cm // 60"
Capacity	1 person	2 persons
Material	PVC 26G / 0,6mm	PVC 26G / 0,6mm
Cover	Nylon 420D	Nylon 420D

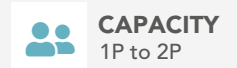



BEAGLE 2P

Dimensions	175 x 150cm
Capacity	2 persons
Material	PVC 26G / 0,6mm
Cover	Nylon 420D



BEAGLE 3P

Dimensions	215 x 170cm
Capacity	3 persons
Material	PVC 26G / 0,6mm
Cover	Nylon 420D



COVER
Nylon 420D



CAPACITY
2P to 3P



BOXER 2P

Dimensions	205x200cm
Capacity	2 persons
Material	PVC 26G / 0,6mm
Cover	Nylon 840D



BOXER 3P

Dimensions	245x190cm
Capacity	3 persons
Material	PVC 28G / 0,7mm
Cover	Nylon 840D



COVER
Nylon 840D



CAPACITY
2P to 3P



LUNA

Dimensions	300x100cm
Capacity	3 persons
Material	PVC 28G / 0,7mm
Cover	Nylon 840D



COVER
Nylon 840D



CAPACITY
3P

**PACK
WAKEBOARD
+ BINDINGS**



Size 39/46 - Lace tightening - flex panels Inserts M6



KYANIT



TOPAZ

Dimensions

135 cm

140 cm

Core

EPS

EPS

Rocker

3 Stages

3 Stages

Use

Cable / Park

Cable / Park

Max. Weight

80 kg

90 kg

Fin set up

2x Single fin

2x Single fin

WAKESURF



OPAL



ONYX

Dimensions

125x50 cm

160x50 cm

Core

EPS

EPS

Channel

X

2

Rocker

Continue

6cm

Deck

EVA + Kicktail

EVA + Kicktail

Use

Wakesurf / Skim

Wakesurf

Max. Weight

80 kg

80 kg

Fin set up

2x Nylon

3x Nylon



KNEEBOARD PYRITE

Lenght	129cm / 50"
Width	51 cm / 20"
Pad	EVA
Handle hook	Yes
Strap	Padded safety strap
Max. Weight	100 kg



SURFSKATE

Dimensions		
Lenght	28"	32"
Width	9"	9'8"
Deck composition		
	7P Canadian maple	7P Canadian maple
Wheels diameter		
	65mm	65mm
Wheels		
Wheels hardness	78 A	78 A
Bearing	ABEC-7	ABEC-7

REVOLUTIONARY INFLATABLE BOATS

MODELS

230CM

250CM

270CM

290CM

DARK GREY

BT-CDS230D

BT-CDS250D

BT-CDS270D

BT-CDS290D

Dimensions	230 x 130 cm	250 x 140 cm	270 x 150 cm	290 x 150 cm
Tubes diameter	36cm	38cm	42cm	42cm
Max. Weight	350 kg	400 kg	450 kg	500 kg
Max. Power	4CV	4CV	8CV	10CV
Floor	Dropstich	Dropstich	Dropstich	Dropstich
Guarantee	2 years	2 years	2 years	2 years
Tube	PVC 0,9mm	PVC 0,9mm	PVC 0,9mm	PVC 0,9mm

LIGHT GREY

BT-CDS230S

BT-CDS250S

BT-CDS270S

BT-CDS290S

Dimensions	230 x 130 cm	250 x 140 cm	270 x 150 cm	290 x 150 cm
Tubes diameter	36cm	38cm	42cm	42cm
Max. Weight	350 kg	400 kg	450 kg	500 kg
Max. Power	4CV	4CV	8CV	10CV
Floor	Dropstich	Dropstich	Dropstich	Dropstich
Guarantee	2 years	2 years	2 years	2 years
Tube	PVC 0,9mm	PVC 0,9mm	PVC 0,9mm	PVC 0,9mm

WOOD BENCH

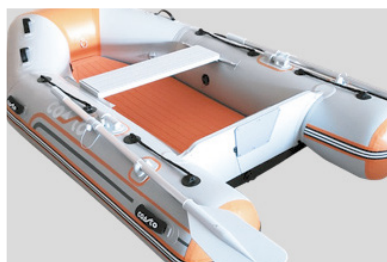

The seat also features an EVA foam surface for maximum comfort and aesthetics.

PVC PATCH



Two PVC patches reinforce the back of the inflatable boat where a battery, a fishing box, snorkelling accessories or any other equipment can be placed without the risk of damaging the floor.

HIGH PRESSURE FLOOR



A high pressure Dropstich technology increases the sturdiness of the floor that come close to a rigid bottom. The EVA foam covering adds comfort to the ride and creates an innovating design that is easy to clean with clear water.

REINFORCING STRIP



All Coasto inflatable boats are equipped with a reinforcing PVC strip under the tubes. With this added protection, the tender can be safely shored on a sand or pebble beach without any risk to the inflated tubes.

CARBON SLAT

MODELS

200CM

230CM

LIGHT BLUE

BT-CSL200B

BT-CSL230B

Dimensions	200 x 130 cm	230 x 135 cm
Tubes diameter	36cm	36cm
Max. Weight	300 kg	350 kg
Max. Power	2.5CV	4CV
Technology	Carbon slat	Carbon slat
Guarantee	2 years	2 years



WOOD BENCH



COASTO dinghies are equipped with a PVC reinforcement strip under each of the tube. This protection is designed to dock on sandy or rocky beaches without damaging the flanges.

CARBON SLAT FLOOR

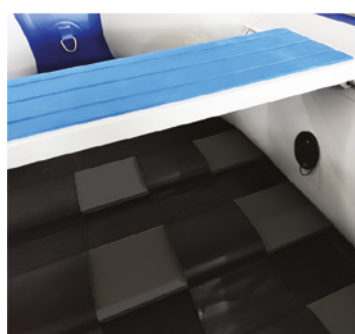

This market-exclusive design provides greater lightness and unprecedented strength, while maintaining good stability.

8 HANDLES



The dinghy is equipped with 8 solid handles, 4 of which are neoprene covered for maximum comfort and safety.

BENCH + EVA

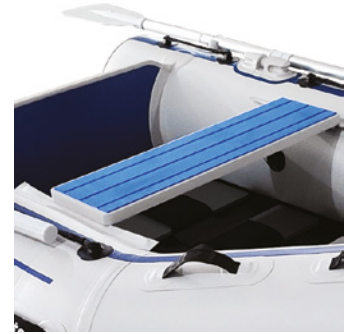

The bench also features an EVA coating for maximum comfort and aesthetics.

ALL INCLUDED

PACKAGE COASTO



X2



INTRODUCING EMOTION INFLATABLE ELECTRIC SUP



UNVEIL THE SECRETS OF THE SHORE!

A unique concept that will appeal to all generations and all levels, from beginners to advanced. The E-MOTION is the result of Coasto's daring creations: a motorized water scooter.

With the E-MOTION, Coasto's concept of inflatable stand-up-paddle is revisited and enhanced. Dare to add a riding bar and a underwater propeller powered by an electrical rechargeable battery and the E-MOTION makes water gliding accessible to everyone. Experienced or not, enjoy all the fun of a stand-up-paddle without the tiresome paddling part.

Take on the water and unveil all the secrets the shores have kept from you until now!

EMOTION SUP

SPECS TARGETS SCOOTER

Waterproofing	IP67
Propulsion	AV/AR
Battery	Removable 12V
Speed	Up to 6 km/h
Autonomy	60 to 90min



ABOUT THE EMOTION ELECTRIC SUP

Its length of over 3 meters and width of over a meter provide this water scooter outstanding stability. The E-MOTION benefits from the same technologies as all Coasto's inflatable stand-up-paddles - dropstitch and double layer fusion - for unequal floatability. The whole surface is covered non slip EVA foam strips. 7 reinforced handles have been placed along the board and at the center for easy handling and better safety. The E-MOTION maximum load capacity can reach 400 pounds!

SPECS TARGETS BOARD

Dimensions	300x105x15cm
Technology	Double layer Fusion
Max load	180kg
PAD	Stripped EVA
Fin	1x Slide in central



ACCESSORIES



LEASH

Dimensions	10' // 3m
Cable	8mm
Leash	Coiled



SURFLOCK

Dimensions	186x90x44mm
Material	Aluminium
Weight	550g
Internal dim.	94x63x41mm



DECKBAG

Capacity	22L
Loading bungee	Yes
Material	TPU



PRESSURE SOLAR SHOWER

Capacity	11L
Dimensions	40x20cm
Hose length	200cm
Tank material	PVC
Head shower material	ABS



SOFT ROOF RACK

Material	Nylon + EVA
Size	133x12x8cm
Capacity	75 kg

- Self inflation

CARBON EPIC

Dimensions	From 170 to 215cm
Technology	Fiber glass + carbon layer
Number of sections	3 sections
Weight	750 - 800 gr
Shaft	FG + carbon layer
Blade	Fiber glass
Float	Yes
Adjustable	Yes

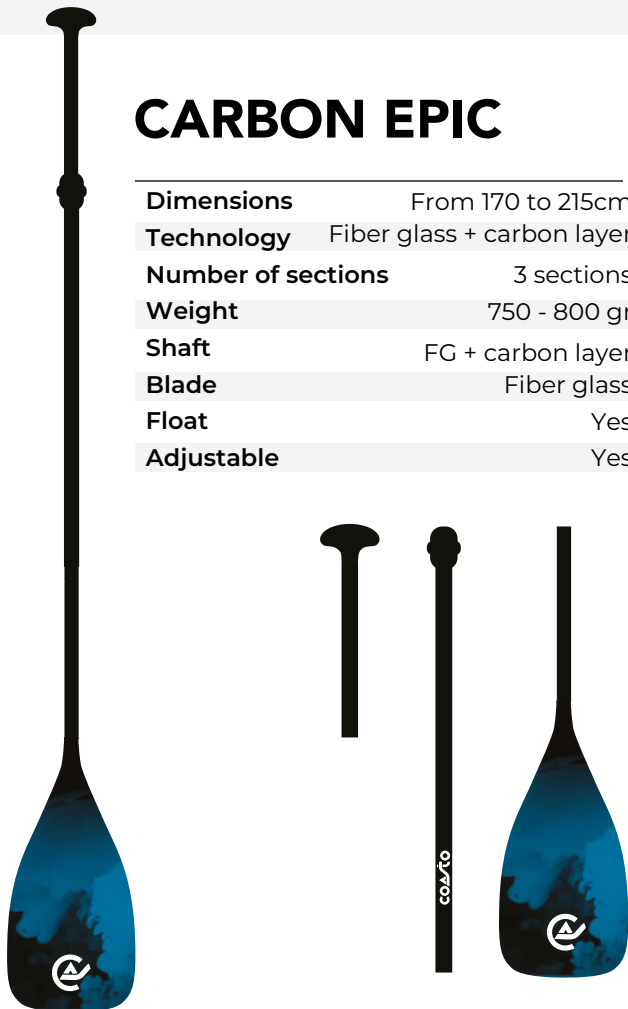

CARBON ADVANCED

Dimensions	From 170 to 215cm
Technology	30% carbon 70% FG
Number of sections	3 sections
Weight	650 - 700 gr
Shaft	30% carbon 70% FG
Blade	Fiber glass
Float	Yes
Adjustable	Yes

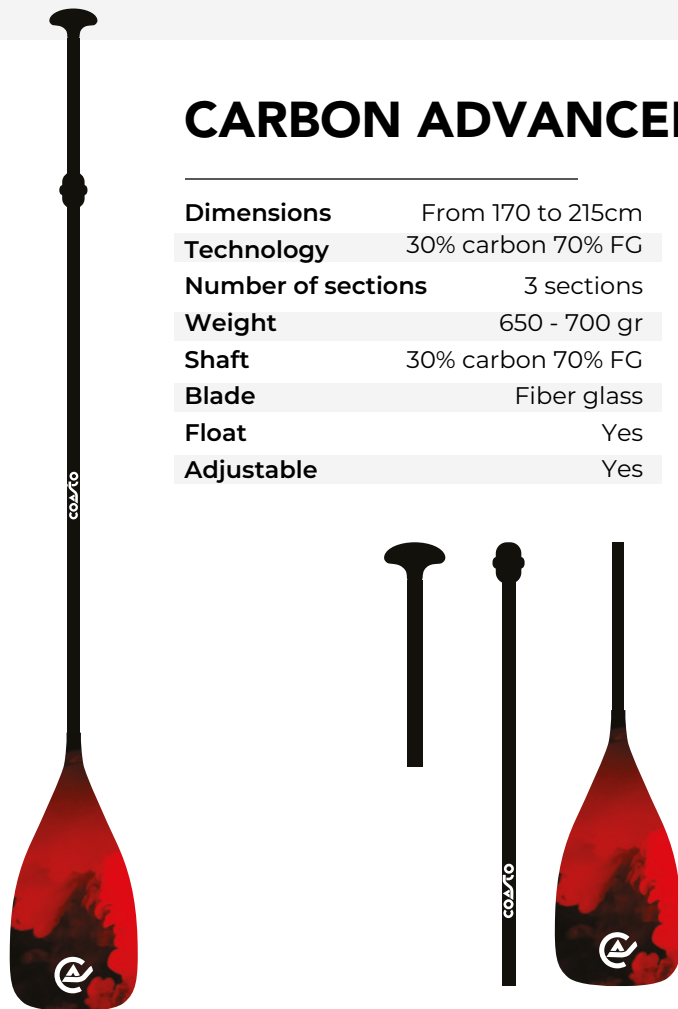

CARBON FEATHER

Dimensions	From 165 to 215cm
Technology	100% Carbon
Number of sections	3 sections
Weight	< 630gr
Shaft	100% Carbon
Blade	100% Carbon
Float	Yes
Adjustable	Yes

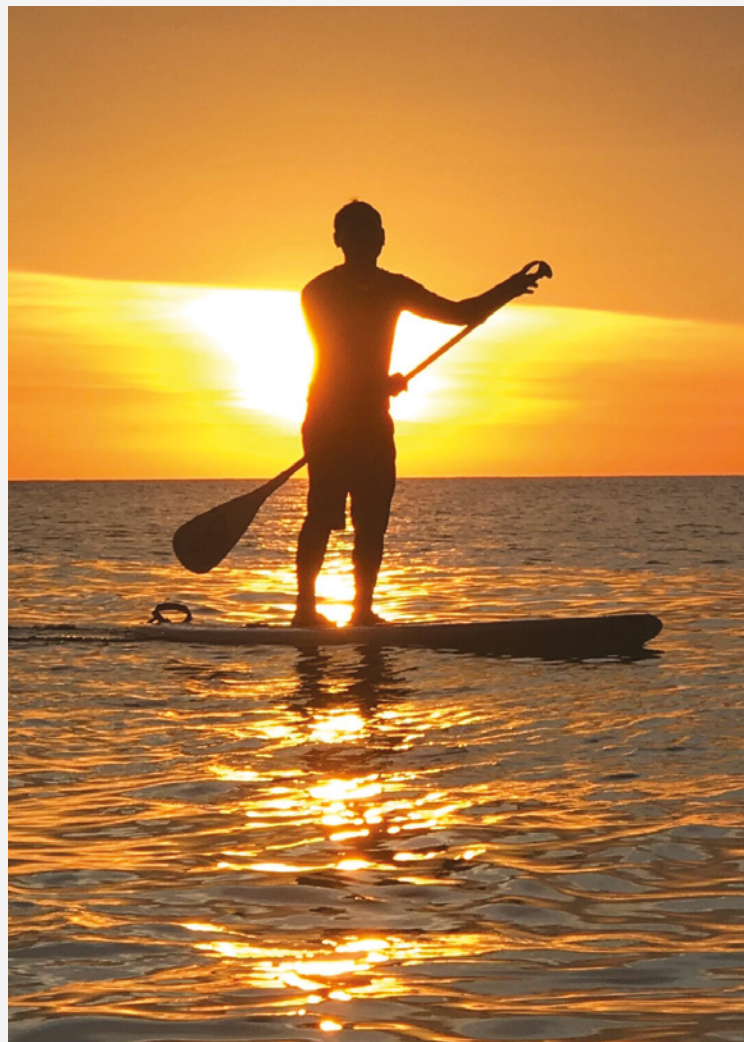
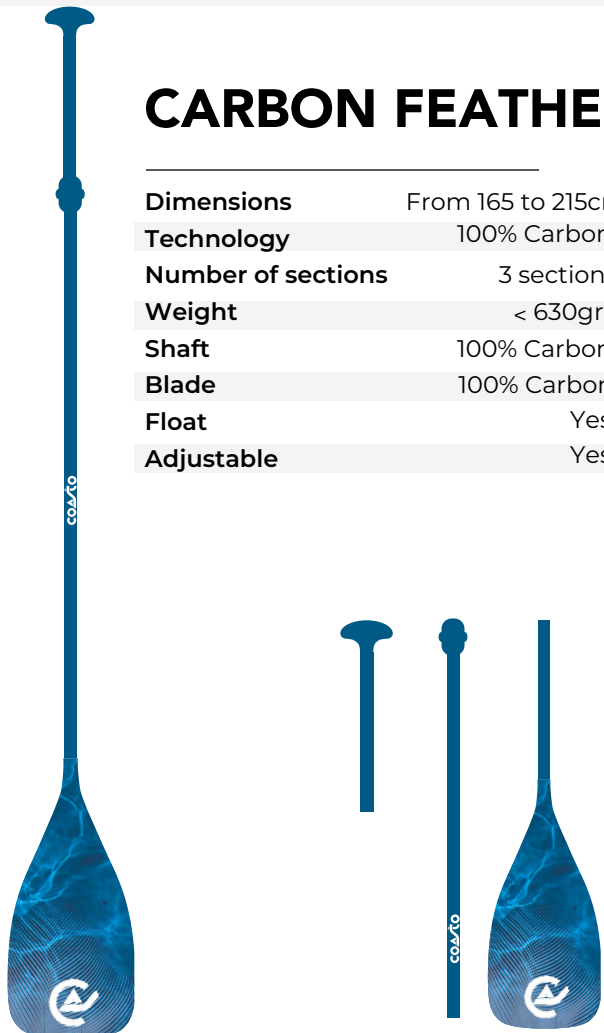

STAR



KAYAK SEAT



PADDLE COLLECTION

**STAR
PUMP**





SHAPE
All-around touring



SIZE
Length, width, thickness

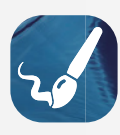

GLOBAL DESIGN



LOGO
Create your own design



EVA
Large options of EVA pads



MAST HOLDER
Optional



HANDLES
Numbers and materials



FIN
Numbers of fins



D-RINGS
Numbers and materials



ACCESSORIES
Paddle, HP Pump, Backpack

CO-BRANDING SMU



BUILD YOUR OWN PRODUCT

STAR SERVICES

SMU OEM SOLUTIONS

IMPRESSED WITH OUR DESIGNS? WE CAN DO BETTER!

All the stand-up-paddles in this catalogue can be personalized to your specifications.

STAR SERVICES is our special OEM service that enables you to put your own brand and personality on these amazing products. Any stand-up-paddle can be created with your own logo and in the colours of your choice.

Select any stand-up-paddle in this catalogue, tell us more about your brand and market, and we will customize it according to your requirements.



KAYAK SEATS

Our seats are compatible with all brands of stand-up-paddles!



NEOPRENE KAYAK SEAT

A SUP kayak seat with back and seating padding for comfort. Low straps add to the stability of the seat.



SUPER DELUXE NEOPRENE KAYAK SEAT

WITH PADDED HIGH SEAT

Reinforced with high back and side straps for ultimate support, this SUP kayak seat offers outstanding comfort thanks to generous padding right through.

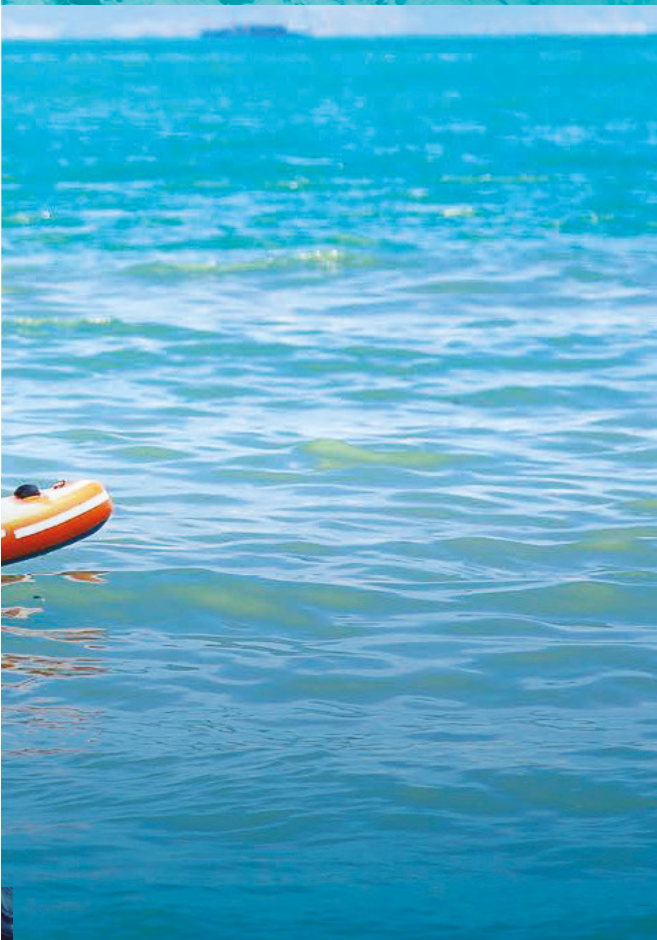

KIDS PADDLE

Dimensions	From 140 to 170cm
Technology	Aluminium
Number of sections	3 sections
Weight	+/- 500g
Shaft	Aluminium
Blade	Aluminium
Float	Yes
Adjustable	Yes



CARBON SWIFT

Dimensions	From 165 to 215cm
Technology	Carbon
Number of sections	3 sections
Weight	< 630gr
Shaft	Carbon
Blade	Carbon
Float	Yes
Adjustable	Yes



ALU 2 IN 1 PADDLE

Dimensions	From 165 to 215cm
Technology	Aluminium
Number of sections	3 +1 sections
Weight	1kg
Shaft	Aluminium
Blade	Aluminium
Float	Yes
Adjustable	Yes



CARBON SPIRIT

Dimensions	From 165 to 225cm
Technology	Carbon / FG
Number of sections	3 +1 sections
Weight	900g
Shaft	Carbon / FG
Blade	FiberGlass
Float	Yes
Adjustable	Yes



CARBON RACE

Dimensions	From 165 to 225cm
Technology	Carbon FG
Number of sections	3 +1 sections
Weight	800g
Shaft	Carbon / FG
Blade	Carbon / FG
Float	Yes
Adjustable	Yes



STAR PUMP REVOLUTION

- Star pump Revolution • SUP pre-inflation up to 4 psi
- Connection via cigarette lighter



Pre inflate your SUP in less than 2 minutes



Reach the 15PSi with your hand in 1 minute



STAR PUMP X

Star Pump power bank
 Portable battery compatible with cigarette lighter
 Battery lithium 6000mAH
 Capacity to inflate 5 to 7 SUP

ELECTRIC AIR PUMP



STAR PUMP 6

Star pump up to 16 psi
 For inflation of stand up paddles
 Regulator adjustment knob to set air pressure.
 Auto stop
 Connection via cigarette lighter



STAR PUMP 7

Star pump up to 16 psi
 For inflation of stand up paddles
 LCD screen to select the correct pressure.
 Auto stop
 Connection via cigarette lighter



STAR PUMP 8

Star pump up to 20 psi
 For inflation and deflation of stand up paddles
 LCD screen to select the correct pressure.
 Auto stop
 Connection via cigarette lighter



STAR PUMP 9

Star pump up to 16 psi
 For inflation and deflation of stand up paddles
 LCD screen to select the correct pressure.
 Battery included
 Led Light and USB charger included
 Auto stop
 Connection via cigarette lighter

STAR PUMP HP

Double or triple action • Manometer



STAR PUMP DOUBLE ACTION

Up to 29 psi
 Double action
 Dismontable
 Manometer

STAR PUMP TRIPLE ACTION

Up to 29 psi
 Triple action
 2x cylinder
 Manometer



SWIM

&

Sports

Pure innovation

960, avenue Olivier Perroy
13790 ROUSSET
FRANCE

www.poolstar.fr